

Green Infrastructure for Southwestern Neighborhoods



Green Infrastructure for Southwestern Neighborhoods

Version 1, August 2010

Written and designed by
James MacAdam

Edited by
Lisa Shipek
Catlow Shipek

for
Watershed Management Group

Illustrations by:
Allen Denomy
Dean Alexander

Cover design by:
Lindsay Ignatowski

Funded by a grant from the United States Environmental Protection Agency and the Arizona Department of Environmental Quality.

Funds for this project were also provided by the Urban and Community Forestry Financial Assistance Program administered through the State of Arizona Forestry Division - Urban & Community Forestry, and the USDA Forest Service.

Available electronically at: <http://www.watershedmg.org/green-streets>

Published by:
Watershed Management Group
PO Box 65953
Tucson, Arizona 85728
520-396-3266
www.watershedmg.org

©2010 Watershed Management Group
All rights reserved

Table of Contents

About green infrastructure	5
<i>Green infrastructure and water quality</i>	7
<i>Principles of green infrastructure</i>	8
General green infrastructure practices	9
<i>Vegetation</i>	9
<i>Mulch</i>	14
Streetside green infrastructure practices.....	15
<i>Working in the right-of-way</i>	15
<i>Curb cuts</i>	17
<i>Curb cut & basin, rock-lined edges</i>	18
<i>Curb cut & basin, shallow slope</i>	20
<i>Sediment traps</i>	22
<i>Other applications</i>	23
In-street green infrastructure practices	24
<i>Working in the street</i>	24
<i>Chicanes</i>	26
<i>Medians</i>	28
<i>Traffic circles</i>	30
<i>Street width reduction</i>	32
Parking lot green infrastructure practices	34
Maintenance.....	37
References	38
Glossary	39
Appendix: plan (overhead) views of green infrastructure practices	40
Acknowledgments	46
About Watershed Management Group	47

What is green infrastructure?

Green infrastructure (GI) refers to constructed features that use living, natural systems to provide environmental services, such as capturing, cleaning and infiltrating stormwater; creating wildlife habitat; shading and cooling streets and buildings; and calming traffic.

GI is a strategy that a growing number of communities are using to manage stormwater more sustainably, while using that water to grow vegetation that provides myriad benefits.

Green infrastructure strategies were developed in temperate areas of North America and are only just beginning to be adapted for use in the hot, arid areas of the southwestern US. These areas face long periods of drought interspersed with intense rainfall that can make implementing GI challenging.

This manual is for community and neighborhood leaders, advocates and professionals who want to use green infrastructure strategies to improve watershed conditions and community liveability in southwestern neighborhoods.

This guide draws on Watershed Management Group's experience working with neighborhoods and local governments to install GI in the Southwest. Design specifics are given only for conceptual understanding, and will always require adaptation based on local site conditions and government regulations.

- This manual provides guidelines for retrofitting existing **neighborhood streets, right-of-ways** and **parking lots** with GI practices.

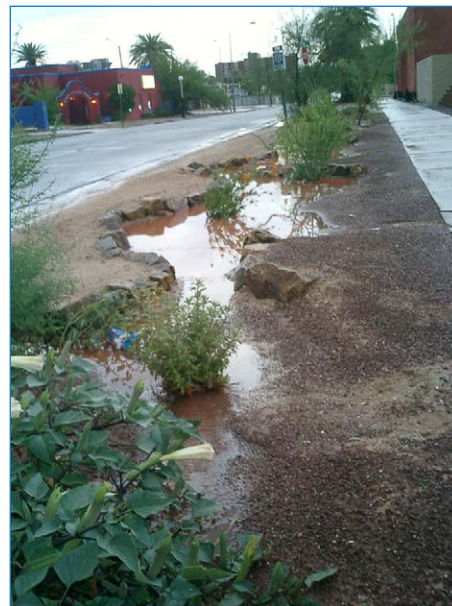

About green infrastructure

The problem

As communities develop, vegetation is removed and soil is covered with asphalt, concrete, and rooftops. These impervious surfaces do not allow water to infiltrate into the ground. The cities of the Southwest are no exception, where automobile-centered infrastructure has created sprawling suburban areas with wide streets and inefficient layouts that maximize impervious surfaces (also known as “hardscape”). When rainfall runs off these surfaces, it:

- floods buildings, streets and waterways
- increases erosion in streams and washes/arroyos
- picks up pollutants like automobile oil, herbicides and pet waste and collects them in receiving waterways

Impervious surfaces also:

- retain and radiate heat, causing the “urban heat island effect,” the phenomenon of developed areas becoming warmer than surrounding rural ones (which in turn causes increased energy consumption and air pollution)
- increase local drought conditions between rainfalls by preventing rainfall from infiltrating into the soil
- are rarely/minimally shaded by vegetation in Southwestern streets and parking lots, making temperatures hotter and neighborhoods less liveable



Grey infrastructure: a concrete channel sends stormwater quickly downstream.



Green infrastructure: a curb cut captures stormwater from the street to feed vegetation.

An integrated solution

Most cities have dealt with increased runoff from hardscape through the use of “grey infrastructure,” such as concrete channels, pipes and barren detention basins.

Grey infrastructure

Pros

- reduces local flooding by sending water out of the system as quickly as possible

Cons

- exacerbates flooding downstream
- concrete channels destroy wildlife habitat and recreation areas in washes/streams
- does not address water quality issues
- serves only one function at high cost
- requires maintenance indefinitely

Green infrastructure

Pros

- cleans stormwater
- can be integrated with other goals like traffic calming and pedestrian/bike safety
- uses self-renewing processes of soil and vegetation that require less maintenance
- provides passive irrigation for street trees and other vegetation, which in turn:
 - shades & cools neighborhood streets
 - provides wildlife habitat
 - beautifies neighborhoods
 - increases property values

Cons

- may not always be able to provide large-scale flood control

Green infrastructure and water quality

Non-point source pollution

Non-point source pollution (NPS) is pollution that comes from dispersed sources like auto oil, pet waste, herbicides, and sediment. When collected by rainfall, these pollutants can become a serious problem for wildlife and human health alike. Other NPS pollutants in developed areas include dust from brake pads and tires, fertilizers, and detergents.

Bioretention

GI addresses the issue of NPS through bioretention, the use of vegetation and soils to clean stormwater runoff. When stormwater flows into an earthen basin lined with plants and mulch, pollutants in the water are filtered out or broken down by these processes:

- *Sedimentation*: sediment drops out of stormwater as it slows and pools.
- *Adsorption*: pollutants like metals, phosphorus, and hydrocarbons attach themselves to clay particles in the soil.
- *Filtration*: vegetation, soil, and plant roots strain organic matter, phosphorus, and suspended solids out of stormwater.
- *Uptake*: plants and soil organisms use nutrients like nitrogen and phosphorus for their growth.
- *Microbial action*: bacteria in the soil and plant roots break down pollutants like nitrogen and hydrocarbons, including some petroleum products¹.



A polluted, degraded wash in Tucson. Washes in similar condition are found across the Southwest.

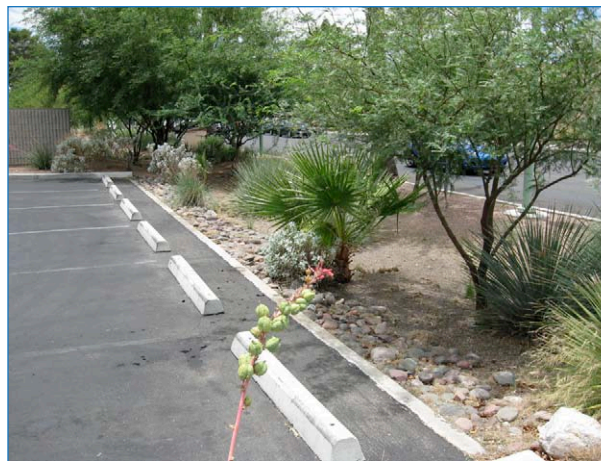

A bioretention basin captures and filters stormwater from a restaurant parking lot and the street.

Washes

Most Southwestern communities are threaded with ephemeral channels called washes or arroyos that flow only periodically. Washes provide important wildlife habitat and are often locations where surface water percolates into groundwater. As development occurs, washes have often been:

- eroded and polluted by runoff from developed areas
- channelized or stabilized with concrete
- relegated to backyards and blocked from view by large walls, where they in turn are:
 - used as sites of criminal activity
 - used as dumping grounds
 - invaded with weedy/non-native plants

GI can help improve conditions in washes by capturing and treating stormwater higher in the watershed, which can:

- reduce erosion and pollution
- reduce the need for concrete storm channels
- create linkages between wildlife habitat in washes and developed areas

Finally, GI moves stormwater management from being “out of sight, out of mind” to being managed in front yards, parking lots, and neighborhood streets. In this way, GI can become a tool to raise people’s awareness and change their behavior relative to water pollution.

GI & water quality • Principles of green infrastructure

Limitations of GI in improving water quality

Whatever we put on the land ends up in the water. Though GI has the capacity to break down many water pollutants, there are many that it cannot (such as some heavy metals). These pollutants will accumulate in GI practices and need to be periodically disposed of properly (for more information on maintaining GI sites, see pages on individual features, and “Maintenance” on page 37). Without changing people’s behavior (like dumping trash or misusing herbicides) and the nature of the products we use (particularly automobiles, which contribute oil, heavy metals, etc. to stormwater), GI cannot solve all the problems of urban non-point source pollution.

Principles of green infrastructure

Though not an exhaustive list, this section outlines a few of the most important principles that should be followed when using green infrastructure practices^{2,3}:

1. Protect and restore natural areas

Natural areas—like forests, grasslands, or relatively undisturbed riparian areas—provide the functions that GI emulates. These areas offer services including air and water filtration, and wildlife habitat. When a natural feature like a wetland is removed, it is costly

and difficult to rebuild the original feature’s complex web of ecological interactions, and thus the services it provides. For this reason it is always preferable to preserve and protect natural areas, not only in places that are being newly developed, but also in the pockets of nature that still exist throughout our cities and towns. In most communities, the undeveloped areas that remain are often degraded from their original state. Working with nature to restore these areas’ ecological functions and services is an essential green infrastructure practice.

2. Serve multiple functions with GI

GI marks a new way of thinking about how we meet our goals as communities. Instead of creating infrastructure that only serves one purpose (like the concrete channel on page 6), the best GI practices will serve multiple functions like calming traffic; improving pedestrian and bicycle pathways; cooling and beautifying streets; reducing and cleaning stormwater runoff; and creating wildlife habitat. Such integrated design creates GI practices that are more cost-effective and desirable to the community.

3. Include the community

GI approaches require a multi-disciplinary and inclusive planning and design process. Including local residents, neighborhoods, businesses, and institutions like schools and churches is essential to creating projects that

are successful and supported over the long term. Through methods like volunteer workshops and tree plantings, even GI construction can be a community-led process that is educational, fun, and builds community connections. Many of the sites shown in this manual were installed by volunteers in public workshops.



At a WMG-led workshop in Tucson, volunteers install bioretention basins in the right-of-way.

General green infrastructure practices: vegetation

Function

Vegetation is an essential element of all green infrastructure practices. The benefits of using vegetation in developed areas are well documented (for trees in particular)⁴, as it:

- cleans air and stormwater of pollutants
- reduces local temperatures by shading hardscape and providing cooling evapotranspiration, which in turn saves energy
- extends the life of asphalt through shading
- provides habitat for wildlife
- builds organic matter in soil
- increases permeability of soil through penetration of roots⁵
- takes up atmospheric carbon dioxide
- beautifies neighborhoods
- adds value to homes
- slows traffic along neighborhood streets
- increases human well-being

Native plants are often the best choice for use in GI practices, as they:

- are uniquely adapted to grow in local soil and climate conditions, including low and variable precipitation in the Southwest
- provide the best habitat for native wildlife
- help create a unique sense of place and connection with the surrounding environment

In Tucson, for instance, South American mesquite species are commonly chosen as



Native bunch grasses (foreground) thrive in a swale that collects stormwater runoff from a parking lot (right, not shown).

landscape trees over the native velvet mesquite for their ability to grow faster and create denser shade canopies. While these are valuable assets, South American mesquites have the following problems that the natives do not⁶:

- produce shallow roots that can damage nearby hardscape
- tend to outgrow their root systems and become vulnerable to uprooting in storms
- produce flowers that many native bees and birds will not frequent
- hybridize with native mesquites in the wild
- require regular irrigation even at maturity

It is often difficult to find non-native plants that provide environmental services better than natives over the long term.

Site selection

Though each unique GI practice has its own site selection guidelines, the following specifics should be followed for plants in all applications:

- Where possible, choose sites where adequate runoff is available to offset or eliminate the need for long-term irrigation of vegetation (see page 12).
- Choose sites in which vegetation will provide maximum desired benefit, such as shading hardscape or cars, calming traffic or creating community gathering spaces.
- Plan for the mature size of plants when selecting and designing GI sites. Planting too densely based on the small stature of young plants can create overgrown landscapes, result in stunted plants that compete for resources, and cause plants to encroach on adjacent areas (e.g. streets, sidewalks, power lines) requiring frequent pruning.

Vegetation: design guidelines

Design guidelines: plant selection & placement

These two pages provide information on the environmental benefits, aesthetics, and appropriate placement of different types of plants used in GI sites. A key consideration for siting plants is where they are placed relative to standing water. During storms, water will pool in bioretention areas for periods of up to several hours (see page 13 for guidelines to ensure infiltration in proper time periods). The trunks and stems of many desert plants will rot when standing in water or where wet mulch lays against their trunks or stems for extended periods.

Trees (a)

Environmental services

- see page 9 for a comprehensive list

Aesthetics

- are unmatched in their ability to create inviting, attractive landscapes

Placement

- should be planted on raised surfaces adjacent to bioretention areas, or on raised terraces within them. Trees' extensive root systems allow them to reach water supplies well beyond the spread of their canopy
- demand more water than other plants, and may require irrigation in areas without significant run-on from hardscape

Other considerations

- are not native to parts of the Chihuahuan,

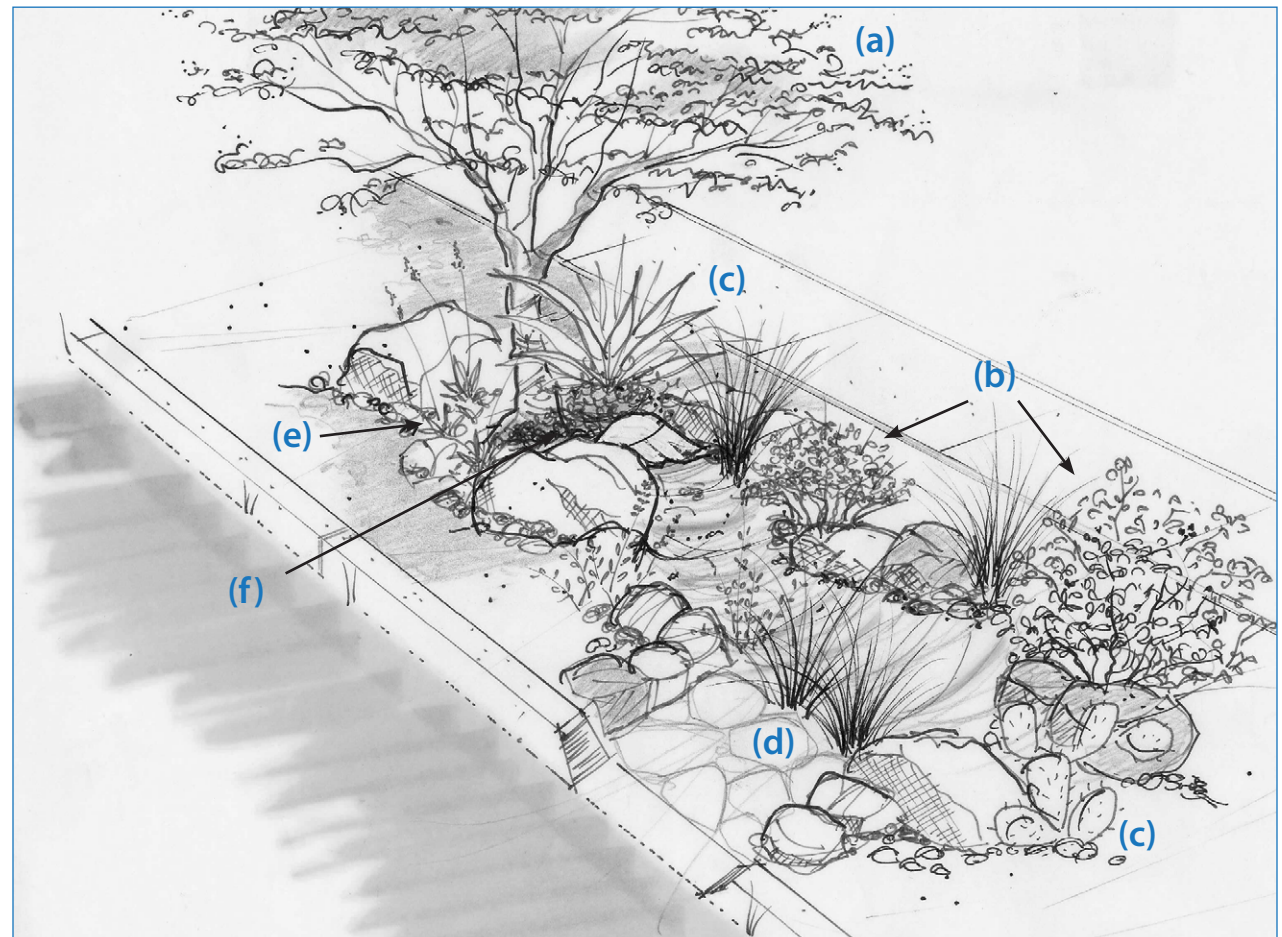

Figure 1. Appropriate locations for siting plants in a green infrastructure practice (shown: curb cut with rock-lined basin).

Great Basin and Mojave deserts—in these areas, non-native trees may have to be used, or trees native to higher elevations, which may have higher water needs

Shrubs (b)

Environmental services

- provide excellent habitat—flowers, fruits,

seeds and cover—for native birds, insects, reptiles and mammals

- reduce erosion by protecting the soil surface

Aesthetics

- create an often missing “mid-story”—an important aesthetic element in landscapes

Vegetation: design guidelines (continued)

between tall trees and smaller plants

Placement

- are best planted on the slope of a basin/swale or on a raised platform just above the level of extended inundation, where they are low enough that their roots can easily reach moisture in the soil but not so low that they will be inundated for extended periods

Cacti, agaves, yuccas (c)

Environmental services

- blossoms and fruits of cacti and succulents are important food sources for a variety of birds, bats and other mammals
- do little to filter stormwater or build soil, thus should not be the only type of plants used in GI sites

Aesthetics

- provide unique, sculptural landscape elements that help define a sense of place
- taller succulents like ocotillos and Joshua trees can provide vertical elements in landscapes that use much less water than trees

Placement

- should be planted above the level of inundation in bioretention basins
- use very little water, and can be used in areas that do not receive extra runoff from hardscape

Grasses (d)

Environmental services

- provide dense networks of stems and roots

that effectively filter stormwater pollutants, reduce erosion, and increase infiltration of stormwater into the soil

Aesthetics

- can provide stunning landscape elements

Placement

- typically survive both inundation and extended drought quite well, and provide the best benefits in cleaning stormwater at the bottom of bioretention areas

Other considerations

- grow throughout the Southwest primarily as bunchgrasses. Many Southwestern environments do not have native turf-forming grasses, which are an essential element of GI practices in other regions

Wildflowers (e)

Environmental services

- provide important food sources for pollinators like hummingbirds, bees, and butterflies

Aesthetics

- are usually the first plants to reach maturity in new GI sites, and can provide much-needed color to sites during the first couple years when trees and shrubs are still getting established
- (seeded annuals) can create a rush of seasonal color in the first rainy season after planting, but will quickly turn to dry stalks when hot/dry conditions return. Plan for maintenance accordingly

Placement

- are variously tolerant of inundation. Seek local knowledge and experiment

Groundcovers (f)

Environmental services

- some perennial wildflowers and shrubs can be used as groundcovers to help protect soil and hold down organic mulch

Aesthetics

- help to create a sense of lushness even in arid areas

Placement

- are variously tolerant of inundation. Seek local knowledge and experiment



A velvet mesquite tree is planted on a terrace above the level of stormwater inundation at this GI site.

Vegetation: design guidelines (continued)

Water management

One of the myths about green infrastructure in the Southwest is that it always requires long-term irrigation. In many cases, the need for long-term irrigation can be eliminated or significantly reduced 1) by using native plants that are adapted to local rainfall patterns, and 2) by placing vegetation in areas where it will receive supplemental rainfall runoff from rooftops, streets, and parking lots.

To create a vegetated GI site that does not require long-term irrigation, create and follow a water budget for the site using one of two methods:

1. For sites where the contributing area of runoff is known (such as a portion of a parking lot discharging runoff to a bioretention basin), use local monthly or annual rainfall averages to calculate how much runoff will flow into the bioretention area over the given time period. Design a planting plan based on the estimated available water. These calculations are expertly detailed and freely available on the web site of Brad Lancaster, author of *Rainwater Harvesting for Drylands and Beyond*⁷.
2. For bioretention features fed from street runoff such as chicanes, medians, traffic circles or curb cut-fed basins, use the method shown in the box at right.

Creating water budgets for bioretention areas in the street or right-of-way, with example for Tucson

Calculating water budgets for GI features capturing runoff from streets is an inexact process. This method assumes that, given the large amounts of runoff generated by streets, an in-street bioretention area like a chicane (p. 26), or a basin capturing street runoff in the right-of-way via curb cuts (p. 18), will fill to capacity with water in rainfall events of a certain size. This method is conservative in that it assumes that a bioretention area will fill only one time during all rain events (i.e. that zero infiltration is occurring). Though infiltration is actually *required* for a GI site to function (see next page), this conservative method is recommended to take into account such factors as climate variability. Observe local conditions to determine if this method is appropriate for your site, and modify as needed.

1. Determine the water holding capacity of the bioretention area (see Reference #7 for details on volume calculations). *Example: A basin in the right-of-way with 3:1 sloping sides (p. 20) is designed to be 20 feet long and 6 feet wide at the full water line, with 8" of stormwater holding depth. Volume = depth x $([L_1 \times W_1] + [L_2 \times W_2]) / 2$; Volume = .66ft x $([20 \text{ ft} \times 6\text{ft}] + [16\text{ft} \times 2\text{ft}]) / 2 = 50.2 \text{ ft}^3$; 1 $\text{ft}^3 = 7.48 \text{ gallons}$; $50.2\text{ft}^3 \times 7.48 \text{ gal/ft}^3 = 375.5 \text{ gallons of stormwater capacity}$*
2. Determine the number of average annual rainfall events in your region. This information may be available locally or through the National Climatic Data Center (www.ncdc.noaa.gov); in Tucson, we contacted Pima County Regional Flood Control Department staff, who did some number-crunching to come up with a figure⁸. *Example: Tucson receives an average of **32.5 discrete (i.e. no rainfall recorded in the previous six hours) rainfall events per year**, which contribute to an average of 48 days of recorded rainfall per year.*
3. Subtract the number of events with rainfall depths less than one-tenth of an inch, as these events will generally not generate runoff⁹. *Example: about 40% of recorded annual rainfall events in Tucson are less than .1 inch. $32.5 \text{ events} \times 60\% = 19.5 \text{ events with more than .1 inch of rainfall}$*
4. Multiply the remaining total number of average rainfall events over .1 inch times the stormwater capacity of the bioretention area to calculate an estimate of available annual runoff to that feature. *Example: $19.5 \text{ events} \times 375.5 \text{ gallons} = 7,322 \text{ gallons of available annual stormwater runoff}$*
5. Design a planting plan appropriate to the estimated annual runoff available to the site (refer to local cooperative extension offices, water departments, landscape manuals, or to Reference #10 in this guide for information on local plant water requirements). *Example: this bioretention feature could support two native velvet mesquite (*Prosopis velutina*) trees with 20' diameter canopies (each requiring approx. 2,940 gallons annually) along with several native shrubs, grasses, wildflowers and cacti¹⁰.*

Vegetation: design guidelines (continued) • maintenance

Water management (cont'd)

- Irrigate plants for a 2-3 year establishment period after planting; reduce irrigation as much as possible thereafter.
- After establishment period, consider occasional irrigation during periods of extended drought (in Tucson, for instance, arrange for deep monthly irrigation in the hottest and driest months of April, May, June and September for 2-3 years beyond the establishment period).
- Provide hand-watering where possible. This method conserves resources, can save costs, save water, and ensure better plant care^{11,12}.
- In areas where long-term drip irrigation is deemed necessary, set irrigation timers to mimic natural rainfall patterns by providing deep, infrequent irrigation (this can reduce maintenance needs by controlling plant growth).

Soils

- All GI sites should be designed to infiltrate their maximum stormwater capacity within 24 hours to avoid mosquito breeding. Conduct a percolation test (a simple test to assess how quickly water is absorbed into soil) to determine infiltration rates.
- In areas with clay soils, hardpan, or caliche (an impenetrable layer of calcium carbonate often found in desert soils), consider removing or boring holes, and/or improv-

ing soil with compost. In some cases, soil may have to be replaced with engineered soil mixes to allow adequate infiltration.

- Avoid compaction of soils during construction, and/or rip soil surface after construction to reduce compaction.
- In areas where the water table is high and/or infiltration is low, underdrains may be needed to be incorporated into bioretention features—these are not covered in this manual.
- Use mulch to improve infiltration (p.14)
- Soil improvements such as compost, minerals etc. do little to enhance the growth of most drought-adapted native plants¹³. However, mixing soil with compost may be a useful tool for improving soil infiltration and moisture retention.

Setbacks

Required setbacks from the City of Tucson are given as an example of the kinds of considerations required for vegetation. Consult the local transportation department for regulations in your area.

- Follow appropriate setbacks from under- and above-ground utilities as determined by local guidelines.
- In areas where transportation visibility is required (usually within any in-street practices and in the ROW at intersections), plant only shrubs lower than 30" and canopy trees that are clear of leaves and branches up to 6'.



Wildflowers create a rush of color in newly installed features in the ROW (above) and a chicane (right).

- Trees should generally be located 3' back from sidewalks and the street.
- Trees whose canopies extend over sidewalks must be pruned to 8' high.
- Trees whose canopies extend into traffic lanes must be pruned to 14' high.

Maintenance

- Use mulch and establish good perennial ground cover to reduce weed growth.
- Prune shrubs and trees to maintain access to pathways and visibility requirements.
- If possible, allow trees to grow 2-3 years with no pruning to build strong trunks.
- Replace plants lost to mortality.

General practices: mulch

Mulch refers to any substance used to cover and protect soil.

- Organic mulch is made up of dry, shredded plant pieces
- Rock mulch is made of gravel or stone

Function

One of the primary functions of mulch in green infrastructure is reducing evaporation of moisture from the soil. This function is crucial in desert areas, where potential evaporation (100" in Tucson) far exceeds rainfall (12" in Tucson). Mulch provides a host of other benefits. For a summary, see the table below.

Site selection & design

Based on its many beneficial characteristics,



A 4" layer of organic mulch dramatically reduces weeds in a neighborhood park. Use organic mulch where stormwater has low velocity.

use of organic mulch is preferred when possible. The main advantage of rock mulch is that it stays put in areas of high pedestrian traffic and significant stormwater flow.

Taking these factors into account, the general rule of thumb for choosing mulch is:

- Use organic mulch in areas where water pools/eddies/is deposited, such as in a basin attached to a curb cut.
- Use rock mulch in areas where water is being transported or where flooding is a concern, such as in a swale or in-street practices.

Other considerations in using mulch include:

- A 4" layer of organic mulch is required to effectively reduce weed growth.

- Keep mulch away from trunks of trees or shrubs to prevent rot.
- Do not use decomposed granite or unwashed gravel in or near infiltration areas, as small particles can fill pore space in the soil and prevent infiltration of water.
- Use larger rock (4"-8" or larger) to reduce erosion in sites where serious flooding is an issue.

Maintenance

- Replenish organic mulch every year to maintain a depth of 3"-4".
- Clean leaf litter from the surface of rock mulch if needed (with organic mulch, leaf litter can be left to help replenish mulch).

Function, costs & benefits of organic and rock/gravel mulch

	Organic mulch	Rock/gravel
Controls weeds	yes	somewhat
Retains soil moisture	yes	somewhat
Regulates soil temperature	yes	no
Builds soil organic matter	yes	no
Reduces erosion	yes	yes
Stays in place in areas of high water flow	no	yes
Provides wildlife habitat	yes	somewhat
Leaf litter that falls must be cleaned up	no	sometimes
Renewable, low embodied-energy resource	yes	no
Cost	low/free*	higher

* Tree-trimming companies will often provide chipped mulch for free.



In this just-installed chicane, 4"-8" rock is used in the channel where stormwater will flow rapidly, and 1" gravel covers upslope areas.

Streetside practices: working in the right-of-way

What is the right-of-way?

Right-of-ways (ROWs) are pieces of land reserved for transportation, utilities and other uses. Neighborhood streets are located within municipally-owned transportation ROWs that usually include the street itself and strips of land on either side where sidewalks, utilities and street trees are often located. For the purposes of this guide, the term right-of-way refers only to the strip of land between the street and private properties.



The ROW (for the purposes of this manual) is the strip of land between the street and private properties. This typical suburban ROW is devoid of vegetation.

Why work in the ROW?

One inch of rain falling on one block of typical city street (40' x 300') generates some 6700 gallons of stormwater runoff. This runoff can become a problem for communities in the form of downstream flooding and non-

point source pollution, or it can become a resource providing moisture for neighborhood vegetation if captured close to the source.

Many Southwestern neighborhood ROWs are un-vegetated, featuring only earthen areas of compacted dirt or uniform gravel. By using the techniques on the following pages, these areas can be turned into rain gardens that infiltrate stormwater from neighborhood streets while growing beautiful trees and shrubs that shade streets and sidewalks. ROWs are legally and logistically easier to work in than the street itself, making them good locations for volunteer-led neighborhood tree-planting efforts and green infrastructure projects.

Site selection, design and workflow

Working in the ROW can be something that is undertaken by a city, a neighborhood group or even an individual homeowner. Though a single curb cut and basin in front of a home may have only a small impact on local stormwater issues, it can provide great benefit as a demonstration of green infrastructure principles and practices that others can clearly see. If a practice is installed as part of an educational workshop or neighborhood volunteer effort, the educational value is magnified as well. The ROW practices featured in the following pages were all installed via volunteer workshops led by WMG.



A Tucson neighborhood ROW captures street runoff to feed a cooling canopy of native trees and shrubs.

When working in the ROW, follow these steps:

1. *Identify owners of adjacent properties and obtain necessary permissions.* The ROW is publicly owned, but adjacent landowners are often held responsible for maintenance of landscape features and vegetation in the ROW in front of their home or business. Landowners may also be held liable for accidents that occur in the ROW. Know your municipality's policies, and get written permission from adjacent landowners. The best sites for working in the ROW are often those where the landowner is actively in-

Working in the right-of-way (continued)

terested: they will tend to be better stewards of the site (doing watering, maintenance) than absentee landlords or disinterested neighbors.

2. *Identify who will maintain the site and how it will be maintained.* This step is often overlooked, and is crucial to the success of any GI site. For more information, see page 37.

3. *Visit the site to assess water flows.* Visiting a site during rain events will provide invaluable information for evaluating appropriate sites for GI, such as:

- How much runoff flows through the site in different size storms? This will help you develop a water budget for the site (p. 12)
- Does stormwater flow along the gutter or in the middle of the street? If the latter, street runoff will not be available to ROW plantings.
- Does stormwater overtop the curb in large storms? If so, plan for erosion control behind the curb.

4. *Locate utilities.* The ROW is often used as a corridor for water, gas and other underground utility lines. Locate lines early in the process, as excavation and/or planting is restricted around them. In Tucson, for instance, mechanical excavation is not allowed within 2-4 feet of a buried utility line. Use a utility locating service (free in most areas) to mark lines on the site, and determine required setbacks for planting and excavation.

Be creative in working around utility lines--sometimes careful hand-excavation close to lines can make a site work. When planting trees, plan around overhead lines.

Note: Many ROW GI projects are made impossible by the presence of underground utilities. Some forward-thinking cities, recognizing that the ROW is an excellent place for planting street trees, require utilities to locate in the street. "Trenchless" approaches are now available that allow utilities to maintain their lines without digging up the asphalt.

5. *Create a water budget for the site.* See page 12.

6. *Create a design.* Use the information on the individual practices (p. 17-32).

7. *Submit the design for permits.* A municipal permit is often required to work in the the public ROW. Contact your local jurisdiction to find out about the permit process.

8. *Conduct pre-excavation if necessary.* Desert soils, particularly if they have been compacted by years of pedestrian traffic, can be incredibly hard. Using machinery to conduct rough excavation of the site will often be necessary. Plan for where excavated soil will go. Using excavated soil locally (such as in raised pathways on-site) can reduce hauling costs.

9. *Cut curbs.* If curb cutting is a part of the project, it should be done after rough excava-

tion and before final installation to facilitate appropriate placement of erosion-control rock (see next page).

10. *Conduct final earth shaping, rock work, planting and mulching.* This can be a great step to involve neighborhood volunteers. The ROW features shown throughout this manual were primarily installed via volunteer workshops.

11. *Visit the site to assess function, maintenance needs and collect information for future sites.* Make changes as necessary. GI sites require ongoing stewardship to preserve their function.

Note: for an excellent step-by-step description of installing a ROW GI site, see reference #12 on page 38.



Volunteers pitch in to create bioretention basins at a ROW GI site in Tucson.

Streetside practices: curb cuts

Curb cuts are openings created in the curb to allow stormwater from the street (or any adjacent impervious surface, like a parking lot) to flow into a depressed infiltration and planting area. This page focuses on the curb cuts themselves; the practices on pages 18-21 give details on how to create the adjacent bioretention areas.

Function

- A useful tool for retrofitting existing neighborhoods with green infrastructure practices without major reconstruction.
- Significantly cheaper than working to collect stormwater via in-street practices.
- Since curb cut openings are perpendicular to the flow of stormwater on the street, they will usually collect only a portion of the water flowing along the gutter. If attenuating stormwater flows along the street is the goal, place multiple curb cuts at intervals along the street.

Site selection

- Crested streets (highest at the middle of the street, carry stormwater along the curb) are appropriate for using curb cuts.
- Observe the site during a rainfall event to determine if and how much stormwater actually flows along the curb where a cut is planned. Even on a crested street, one side may be higher than the other or flows may be altered by upstream factors. Also, small divots or cracks in the pavement may direct

runoff from small rainfall events away from the curb.

- Avoid streets with slopes greater than 5% or in areas where the curb is routinely submerged.
- A permit and/or licensed contractor may be required for curb cuts along the ROW. Check with your municipality's transportation department for permit information as well as required setbacks and location guidelines (in the City of Tucson, for instance, curb cuts must be 5' away from driveway aprons and 20' back from intersections).
- Minimum width of earthen area between curb and sidewalk/path must be at least 6' wide in areas with on-street parking (5' without parking).



A curb cut draws stormwater from the street into a bioretention basin in the right-of-way.



A rock apron protects against soil erosion where curb cuts draw stormwater into bioretention areas.

Design and construction

- Make curb cuts 18"-24" across, with 45° sloped sides, or per local guidelines.
- Bottom of curb cut should slope slightly toward basin area (away from street).
- A rock "apron" should be built where the water flow crosses the cut curb into the ROW area. The apron will prevent soil erosion and undercutting of the road surface. Rock sized 4"-8" can be laid in a single well-fitted course around the entrance. The top of the rock surface should be laid 1-2" below the level of the bottom of the curb cut to ensure positive water flow into basin.

Maintenance

- Regularly clear curb cuts of any debris that may prevent the free flow of stormwater into basins (1-2 times per year).
- Check rock apron for signs of erosion and repair/reinforce as needed (annually).

Streetside practices: curb cut & basin, rock-lined edges

To collect and infiltrate stormwater from curb cuts into the right-of-way, bioretention basins must be excavated in the ROW to a depth below street level. Rocks are used to prevent erosion along the sides of the basin.

Function

Advantages

- Can be used to collect stormwater from relatively narrow ROWs.
- Rock edges create a delineated area for mulch and planting.

Disadvantages

- Rock edges often stand out in landscape (for better or for worse).
- Rock edge and basin may be considered a pedestrian tripping hazard in high-use areas.
- Basin slopes can erode if not properly lined with well-placed rock.

Site selection

- Follow site selection guidelines for curb cuts (p. 17) and vegetation (p. 9).
- Minimum width of earthen area between the

curb and sidewalk/path must be at least 6' wide in areas with on-street parking (5' without parking).

Design and construction

- Avoid streets with slopes greater than 5%.
- Maintain setbacks from above- and below-ground utilities as required.
- Excavate bottom of basin 10"-12" below the surface of the street and backfill with 2"-4" of mulch (note: in Tucson, basins must not allow standing water deeper than 8". Excavating deeper and backfilling with mulch allows greater stormwater capacity—at minimum, top of mulch must be at least 2" below the curb cut inlet).
- In areas where the slopes of the basin will exceed 33%, the edges of the basin must be lined with rock to prevent erosion.
- If pedestrian access to cross the ROW is needed, size basins no longer than 20' in length, with 5' level pathways between basins.
- Make level area at bottom of basin as large as possible to maximize stormwater infiltration.



- In areas with on-street parking, preserve an 18" "step-out zone" of flat soil or gravel (sloped 1% toward basin) next to curb to allow passengers to step in and out of vehicles.
- Preserve a 1'-wide area, slightly sloped (1%) toward basin next to pedestrian pathway or sidewalk.
- If sidewalks are not present, preserve a minimum 4' flat pedestrian pathway within the ROW (sloped 1% toward basin).
- Curb cut should be both the inlet and the overflow outlet of the basin. To achieve this, the bottom of the curb cut should be at least 4" below any other point along the edge of the basin. This step is imperative to ensure that overflow exits back onto the street and not onto adjacent properties. The more a site is sloped, the shorter the basin must be to maintain these levels.
- Create planting shelves along the basin to support native trees and shrubs. Be sure planting shelves do not block flow of stormwater along the basin length.

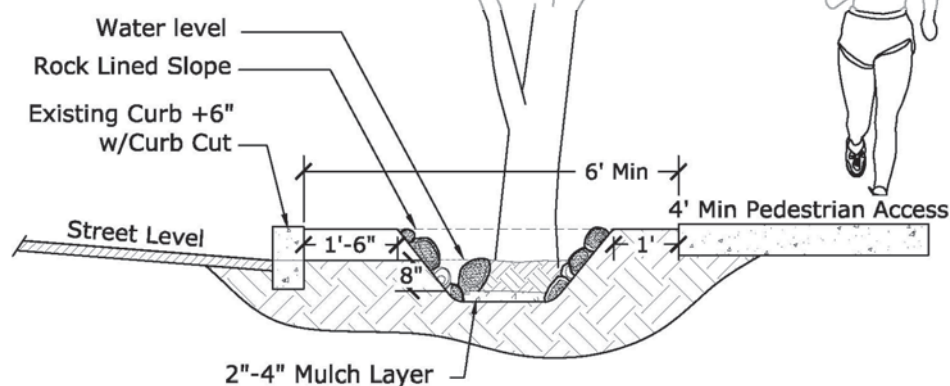

Figure 2. Typical cross-section of a basin with rock-lined edges, showing typical setbacks for a site on a residential street with on-street parking (for plan view see Appendix).

curb cut & basin, rock-lined edges (continued)

- To preserve visibility, do not plant trees or shrubs that will encroach into travel lanes. A tree canopy may extend over parking areas at a minimum height of 8'-9', or travel lanes at 14' (refer to local codes).

Materials

- Use 8"-16" rock to line the basin's perimeter.
- Use 4"-8" rock as an apron around curb cuts to reduce erosion.
- Use organic mulch in basin wherever possible. If street experiences severe flooding then rock mulch may be necessary.

Maintenance

- Observe basin during rain events to evaluate function and make necessary adjustments.
- Periodically remove accumulated trash.
- Add organic mulch to maintain maximum depth of 8" (or designed depth) from street surface (annually).
- If rock mulch is used, remove plant debris from mulch surface (1-2 times per year).
- Remove accumulated sediment from bottom of basin to retain designed depth (every 1-2 years). In areas with high sediment loads consider using sediment traps (p. 22).
- Check inlet apron, slopes, edges etc. for ero-

sion and repair as needed (annually).

Adapting the practice to your site

- In ROW areas without on-street parking, reduce "step-out zone" to a minimum of 6".
- If utilities cross the ROW perpendicularly, use these areas as raised pathways for pedestrians to cross the ROW between basins.
- In areas where the ROW is not wide enough for this practice, consider creating smaller basins without curb cuts to capture runoff from adjacent sidewalk/path and properties (p. 23).

A minimum 6' wide area between curb and sidewalk is needed for this practice (this allows 1.5' of level bottom 8" below street level; width can be 5' min. if there is no on-street parking)

18" flat step-out zone between inside of curb and rock edge allows people to step out of their cars onto a flat surface; slope 1% towards basin to collect rainfall (this zone can be reduced to 6" at sites without adjacent parking)

Curb cut inlet lined with 4"-8" rock to reduce erosion

18"-24" curb cut with 45-degree sloped sides; serves as both the inlet and outlet of basin

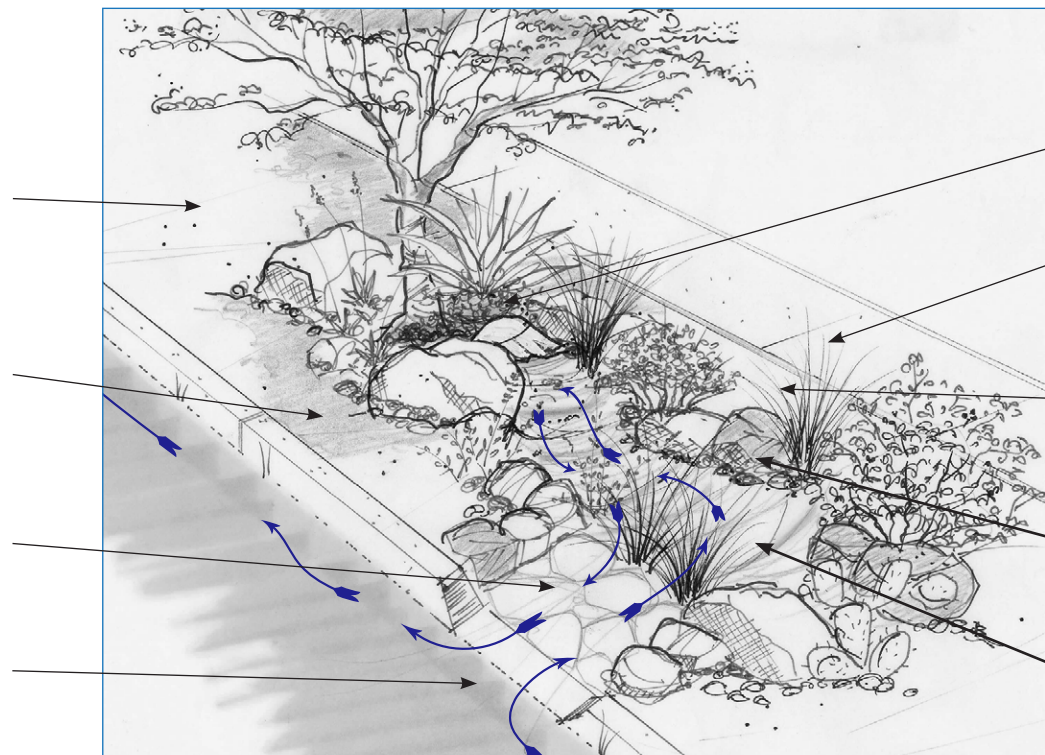

Trees and water-sensitive plants are placed on terraces above level of regular/extended inundation

Sidewalks/pedestrian paths slope 1% toward basin

12" flat safety zone between sidewalk/pedestrian pathways and rock edge; slope 1% towards the basin to collect rainfall

All slopes greater than 33% are protected by 8"-16" set-in rock

Area of level bottom is maximized to increase stormwater infiltration

Figure 3. Conceptual drawing of a curb cut and rock-lined basin in the ROW.

Streetside practices: curb cut & basin, shallow slope

One option for using curb cuts in areas with wide (9' or wider) earthen areas between curb and sidewalk (ROW) is to create basins with shallow slopes that are not lined with rock. These basins are similar in structure and function to basins with rock-lined edges (page 18), the main difference being the use of sloping sides. This is made possible in areas with a greater right-of-way width.

Function

Advantages

- Gently sloping sides are safer for pedestrian environments
- Slopes do not require rock lining
- Blends in with surrounding landscape

Disadvantages

- A relatively large earthen ROW area is required to install this practice
- The clear boundary of a rock edge is absent, which may result in more pedestrian traffic through planted areas, and may present challenges in keeping mulch in place

Site selection

- Follow site selection guidelines for curb cuts (p. 17) and vegetation (p. 9).
- Minimum width of earthen area between the curb and sidewalk/path must be at least 9' wide in areas with on-street parking (8' without parking).
- Avoid streets with slopes greater than 5%.
- Maintain setbacks from above- and below-ground utilities as required.

Design and construction

- Excavate bottom of basin 10"-12" below the surface of the street and backfill with 2"-4" of mulch (note: in Tucson, basins must not allow standing water deeper than 8". Excavating deeper and backfilling with mulch allows greater stormwater capacity—at minimum, top of mulch must be at least 2" below the curb cut inlet).
- If pedestrian access to cross the ROW is needed, size basins no longer than 20' in length, with 5' level pathways between basins.

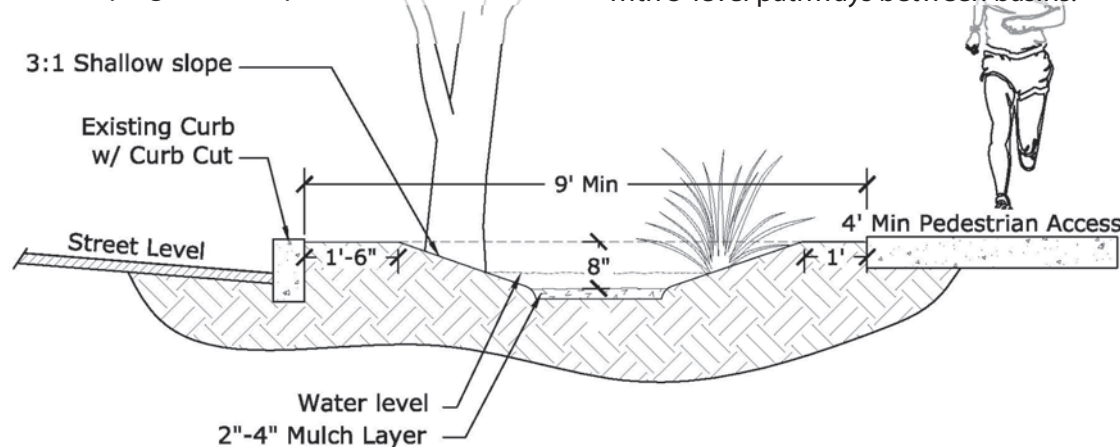

Figure 4. Typical cross-section of a basin with sloping sides, showing typical setbacks for a site on a residential street with on-street parking. For plan view see Appendix.

- Make level area at bottom of basin as large as possible to maximize stormwater infiltration.
- In areas with on-street parking, preserve an 18" "step-out zone" of flat soil or gravel (sloped 1% toward basin) next to curb to allow passengers to step in and out of vehicles.
- Preserve a 1'-wide area, slightly sloped (1%) toward basin next to pedestrian pathway or sidewalk.
- If sidewalks are not present, preserve a minimum 4' flat pedestrian pathway within the ROW (sloped 1% toward basin).
- Curb cut should be both the inlet and the overflow outlet of the basin. To achieve this, the bottom of the curb cut should be at least 4" below any other point along the edge of the basin. This step is imperative to ensure that overflow exits back onto the street and not onto adjacent properties. The more a site is sloped, the shorter the basin must be to maintain these levels.
- Create planting shelves along the basin to

curb cut & basin, shallow slope (continued)

support native trees and shrubs. Be sure planting shelves do not block flow of stormwater along the basin length.

- To preserve visibility, do not plant trees or shrubs that will encroach into travel lanes. A tree canopy may extend over parking areas at a minimum height of 8'-9'; or travel lanes at 14' (refer to local codes).

Materials

- Use 4"-8" rock as an apron around curb cuts to reduce erosion.
- Spread 2"-4" layer of organic or rock mulch across basin, including bottom and slopes.

Maintenance

- Observe basin during rain events to evaluate function and make necessary adjustments.
- Periodically remove accumulated trash.
- Add organic mulch to maintain maximum depth of 8" (or designed depth) from street surface (annually).
- If rock mulch is used, remove plant debris from mulch surface (1-2 times per year).
- Remove accumulated sediment from bottom of basin to retain designed depth (every 1-2 years). In areas with high sediment loads consider using sediment traps (p. 22).
- Check inlet apron, slopes, edges etc. for erosion and repair as needed (annually).

Prune vegetation to preserve visibility and prevent obstruction of travel lanes and pedestrian pathways (annually).

Adapting the practice to your site

- In ROW areas without on-street parking, reduce "step-out zone" to a minimum of 6".
- If utilities cross the ROW perpendicularly, use these areas as raised pathways for pedestrians to cross the ROW between basins.
- If no or very little pedestrian access across the ROW is needed, consider making basins into an elongated swale (p. 23) to increase stormwater capacity.

A minimum 9' wide area between curb and sidewalk is needed for this practice (this allows 2' of level bottom 3" below street level; width can be 8' min. if there is no on-street parking)

Trees and water-sensitive plants are placed on terraces above level of regular/extended inundation

18" flat step-out zone between inside of curb and top of slope allows people to step out of their cars onto a flat surface; slope 1% towards basin to collect rainfall (this zone can be reduced to 6" at sites without adjacent parking)

Curb cut inlet lined with 4"-8" rock to prevent erosion

18"-24" curb cut with 45-degree sloped sides; serves as both the inlet and outlet of basin

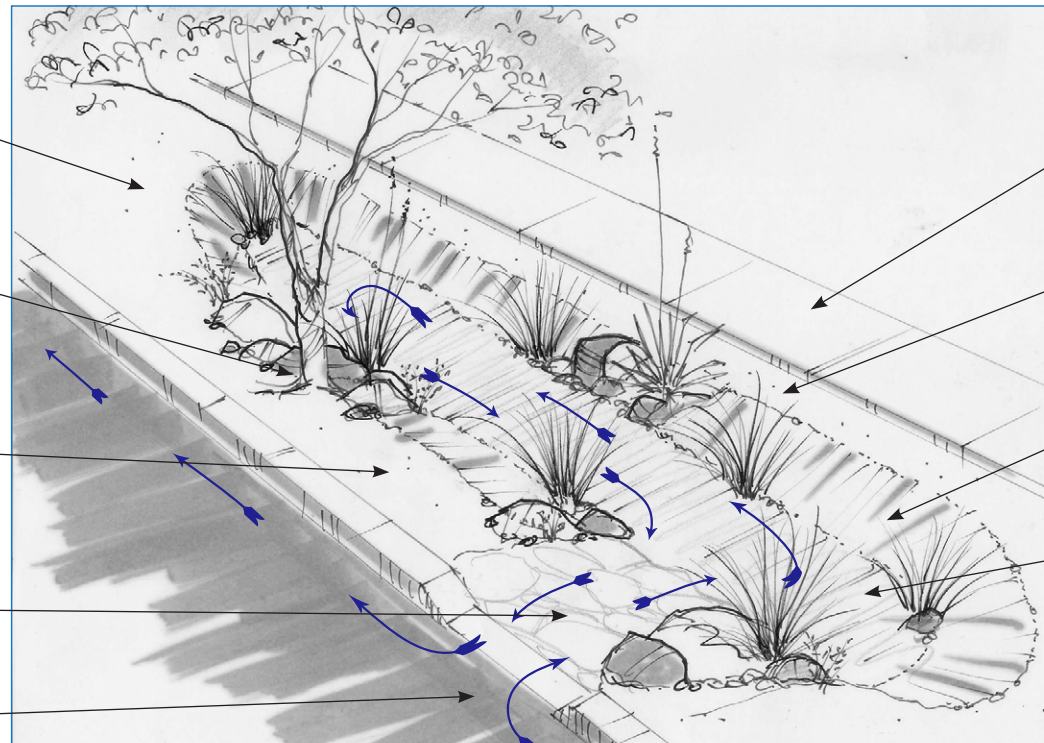

Sidewalks/pedestrian paths slope 1% toward basin

12" flat safety zone between sidewalk/pedestrian pathways and rock edge; slope 1% toward the basin to collect rainfall

All slopes are made less than 33% to eliminate the need for rock reinforcement

Area of level bottom is maximized to increase stormwater infiltration

Note: this illustration shows an intentionally under-vegetated basin to show slope contours.

Figure 5. Conceptual drawing of a curb cut and basin with shallow slopes in the ROW.

Streetside practices: sediment traps

Sediment removal poses a considerable challenge in the maintenance of GI sites. In the arid Southwest, high proportions of bare soil are common, yielding faster rates of erosion and sedimentation. This requires that GI sites in areas of high flow be armored with rock or gravel, which in turn makes sediment removal more problematic. Sediment traps address this issue.

Function

Sediment traps capture and collect sediment at the entrance to bioretention areas, facilitating periodic sediment removal and extending the functional life of these features.

Site selection

- Use sediment traps in areas where high sediment loads are observed in stormwater.
- Traps can be used at the inflow of any GI feature--these diagrams show an example for use with a curb cut and rock-lined basin.

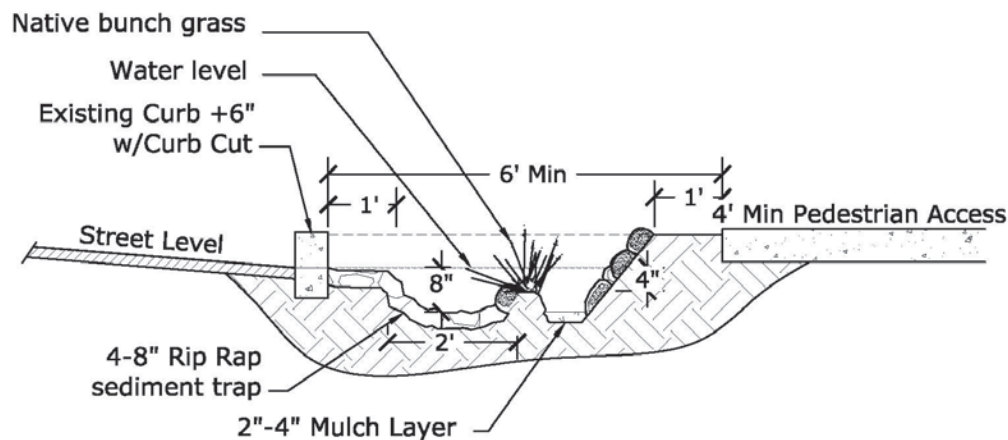

Figure 6. Typical cross section of sediment trap for curb cut with rock-lined basin.

Design and construction

- Excavate an 8" depression 1' from the inside of curb cut, approximately 2'x2'.
- Create a 3"-4" earthen berm separating this area from the rest of the basin.
- Plant berm with native bunchgrasses to stabilize berm and filter stormwater pollutants.

Materials

- Line curb cut apron, bottom of sediment trap, and slope of berm with a single well-placed course of 4"-8" rock.

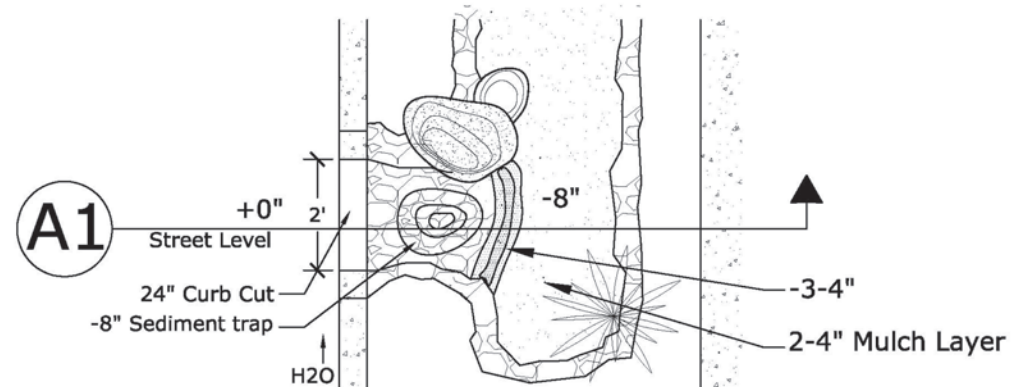

Figure 7. Plan view of sediment trap for curb cut with rock-lined basin.

- Tie 4"-8" rock (above) into rock edges of larger basin (see plan view above).

Maintenance

- Check feature to ensure stormwater inlet does not become blocked (before/after rainy seasons).
- Remove sediment from bottom of trap (frequency will depend on sedimentation rates).
- Check apron, slopes, edges etc. for erosion and repair/reinforce as needed (annually).

Adapting the practice to your site

- This concept will work for many GI applications beyond the one shown. The key concept is to create a place where water will pool momentarily to allow coarse sediments to drop out of stormwater, before it spills over into the rest of the bioretention feature.
- Always ensure that the top of the retention berm is a minimum of 4" below the bottom of the stormwater inlet (or flush curb).

Streetside practices: other applications

Swale with curb cuts

A swale is a bioretention feature with gently sloping sides that is long and linear in shape. A swale may capture and infiltrate stormwater in place (when level-bottomed), or transport water downhill to a drain or other detention feature. In the example below, a long swale was created to capture stormwater from the street via a series of curb cuts.

This design is very similar to the shallow-sloped basins on page 20 (it can have an identical cross-section), the difference being that the swale is one long continuous feature rather than being broken up into individual basins.



This long, shallow ROW swale has multiple curb cuts along its length.

This practice would not work in areas where more frequent pedestrian crossing of the ROW is required, or on steeper slopes where erosion might be caused by the through-flow of water in and out of curb cuts (this is avoided in the basin designs by making the curb cut both the inlet and overflow of the basin).

Basin or swale without curb cuts

In areas where the ROW is too small to create a basin with curb cuts or where stormwater does not flow along the gutter, bioretention areas may still be created to capture runoff from sidewalks and adjacent properties.

- If only collecting runoff from an adjacent sidewalk (versus from a street or parking



At this site in Tucson, a 3" deep swale was created in the ROW to collect runoff from the sidewalk and adjacent property.

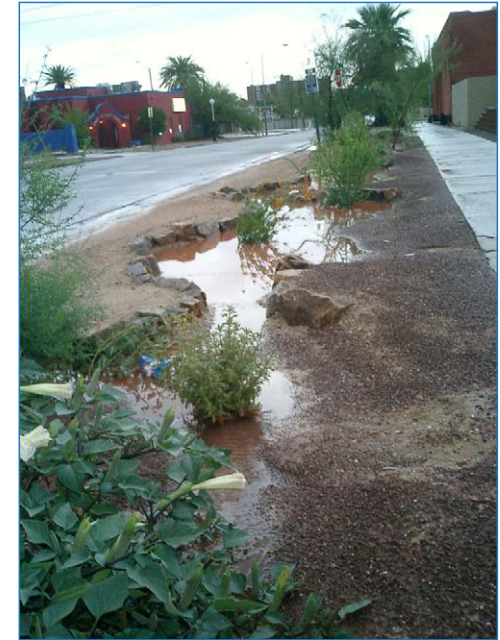

This series of basins collects stormwater from the adjacent sidewalk and businesses (without curb cut).

lot), this method will generally provide less passive stormwater irrigation to plants.

- Downspouts from adjacent buildings can be directed into basins in the ROW (these must be sized appropriately to capture and infiltrate the calculated rooftop runoff).
- Since no curb cut is present to serve as the overflow for bioretention features, ensure that overflow is directed to the street and not on to adjacent properties.

In-street practices: working in the street

The problem: too much street

Too many southwestern streets are:

- too wide
- barren of vegetation
- hot and unfriendly to bicyclists and pedestrians

They generate stormwater runoff that:

- carries non-point source pollution to waterways
- floods the street creating traffic hazards
- erodes soil downstream of paved areas
- increases maintenance costs

A solution: green infrastructure

In-street GI features include :

- chicanes
- medians
- traffic circles



These features reduce the street width and create pervious planting areas, which:

- calm traffic
- reduce flooding, sedimentation, and erosion
- capture, clean, and infiltrate stormwater
- grow vegetation that shades streets and sidewalks, cooling neighborhood temperatures and creating more desirable places for biking and walking

Why work in the street?

The following points outline the advantages and disadvantages of using in-street green infrastructure practices versus working only in the right-of-way with curb cuts and basins.

Advantages

- possible in areas with small/impervious ROW
- can capture more stormwater
- better calms traffic
- dramatically affects streetscape & neighborhood aesthetics

Disadvantages

- more expensive
- more disruptive (can displace parking, more construction, etc.)
- more contentious (because of cost and disruption)
- may not be possible in areas where stormwater conveyance is needed



Chicane



Median



Traffic circle

Working in the street (continued)

Site selection, design and workflow

Preserving street width

To preserve access for emergency vehicles, the Uniform Fire Code requires that each lane of traffic must be at least 10' wide (some municipalities may require greater width; in the City of Tucson for instance, traffic lanes on residential streets must be 11' wide). An 8' width is also required for each lane of parallel parking along the curb. For example, a street with two lanes of traffic and parallel parking on one side could be a minimum of 28'. Any width over 28' could potentially be incorporated into a feature like a chicane, median, or street width reduction. Consider reducing on-street parking to make installing these practices possible.



Many southwestern streets are designed to convey stormwater.

Stormwater conveyance

Many Southwestern streets are designed to convey stormwater. In Tucson, for instance, many “washes,” or designated waterways are actually streets that flow with large amounts of stormwater in powerful desert storms, in which the street functions as the “river bottom” and the curbs act as the “river banks.” In these situations, adding a raised median or a curb extension to the street can reduce the street’s stormwater capacity and increase the risk of flooding adjacent properties. GI practices designed for southwestern streets will need to take this unique challenge into account. In general, the solution is found by creating in-street GI features that have flush curbs and bioretention areas depressed below the level of the street (see following pages).

Bicycles and pedestrians

The in-street GI practices described in this manual are all designed to calm traffic. Chicanes, medians and traffic circles all create obstructions in the roadway that force drivers to slow down. While they also create obstacles for bicyclists, slower overall traffic speeds mean that serious injury accidents involving bicyclists and pedestrians are less likely to happen¹⁴. In addition, chicanes and medians at intersections can reduce pedestrian crossing distances (by reducing the distance between the curbs) and increase visibility for both drivers and pedestrians (by keeping



parked cars farther away from intersections). These properties of in-street GI features make them a great option for those neighborhoods seeking to reduce cut-through traffic and generally make streets safer and more livable.

Workflow

Because they are on public streets, these GI features generally require a high level of government involvement in the design and installation process. Workflow of in-street projects will likely be determined by local official protocols. However, local knowledge about stormwater flows, dangerous intersections, neighborhood goals, etc. are invaluable to the planning and design process—and sadly, often overlooked. This manual is intended as a bridge to provide neighborhood residents with relevant information to contribute to planning processes, and to offer officials a neighborhood perspective on green infrastructure.

In-street practices: chicanes

Also called bump-outs or curb extensions, chicanes are features along the side of the street in which the curb “bumps out” into the street to slow traffic.

Function

When designed with a flush curb and depressed bioretention area, chicanes collect and infiltrate stormwater that flows along curbs.

Site selection

- Chicanes function best to collect stormwater on streets that are crested, or highest at the middle of the street, and that carry stormwater along the curb. The design shown is for a chicane on a crested street.
- Chicanes may be used effectively both mid-street and at corners of intersections. Consider incorporating chicanes with pedestrian crossings to shorten crossing distance and restrict parking near intersections.
- Most chicanes require a minimum of 8' of

available (surplus) street width. See page 25 for details on preserving appropriate street width.

- Take on-street parking needs into consideration. Chicanes will displace existing on-street parking.
- On steeper sloped roads (> 2%), berms may need to be used to slow stormwater flowing through the bioretention features.
- In some cases chicanes may not be desirable for designated bicycle routes. However, when evaluating chicanes' effect on bicycle safety, consider the improved safety of slower vehicle traffic.
- Ensure the boundaries of the in-street bioretention area are well marked and visible to traffic, bicyclists, and pedestrians.

Design and construction

- Chicanes should be sized as large as possible to increase stormwater mitigation and traffic

calming effects. They are often about the size of a parking space (8'-10' wide by 18'-20' long).

- Excavate the inside of the chicane to a final depth of 8" (e.g. if covering soil with 4"-8" rock, excavate 4"-8" deeper to bring the final depth to 8").
- Where possible, extend vegetated and depressed bioretention areas into the adjacent ROW. This may be achieved by laying ROW slopes back (see plan view in Appendix), or by pouring a new curb deeper into the ROW (see Figure 9 next page).
- Maximize the area of level bottom of the chicane by using steep (up to 50%) side slopes armored with rock.
- Use flush header curbs 18" deep to protect the adjacent asphalt surface.
- Create raised planting areas for trees and shrubs that do not tolerate inundation. The raised planting areas can additionally function to slow stormwater flow through the bioretention area.
- To preserve visibility, do not plant trees or shrubs that will encroach into travel lanes. A tree canopy may extend over a travel lane at a minimum height of 14' (refer to local codes).

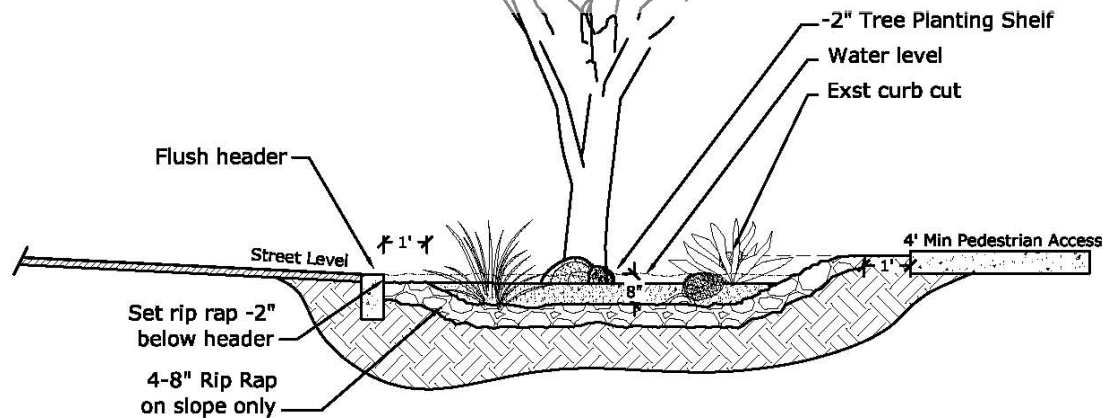

Figure 8. Typical cross-section of a chicane with flush curb and depressed bioretention area. For plan view, see Appendix.

chicanes (continued)

curb to discourage entry by automobiles.

- Place flashing solar lights on the asphalt to warn oncoming traffic of obstruction.

Maintenance

- Check slopes, edges, etc. for signs of erosion and repair/reinforce as needed (before each rainy season).
- Observe bioretention feature during rain events to evaluate function and make necessary adjustments.
- Prune vegetation to preserve visibility and

prevent obstruction of travel lanes and pedestrian pathways (annually).

- Remove accumulated sediment from bottom of basin to retain designed depth (every 1-2 years).

Adapting the practice to your site

- If chicanes are designed for concave streets (with the lowest point in the middle of the street), use a uniformly raised curb and a depressed planting area to capture and infiltrate stormwater that falls on the chicane itself and

the adjacent ROW.

- In areas with higher sediment flows, consider using sediment traps (p. 22) to facilitate maintenance.
- For streets where maintaining maximum stormwater conveyance is not an issue, chicanes with raised curbs (and a flush stormwater inlet) can also be used (see photo below).



Trees and other plants with water-sensitive trunks/stems are planted on slopes or terraces above the level of regular inundation

Larger boulders are used to increase visibility and deter vehicles

Flush header curb 18" deep, mounted with 6" ceramic disks to increase visibility and deter vehicles

Edges of bioretention area adjacent to curb are lined with 4"-8" rock apron

Flashing solar lights are placed on asphalt to increase visibility to oncoming traffic (not shown, see Appendix)

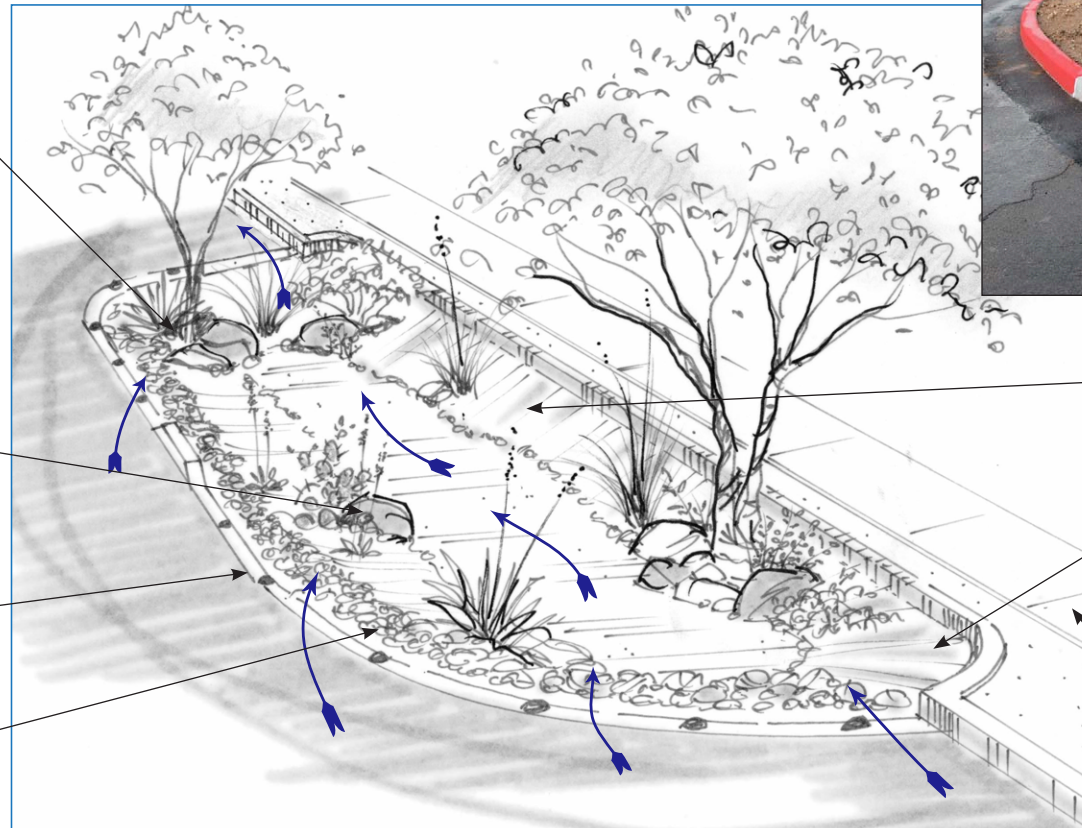

Steeper slopes (up to 50%) are used to maximize area of level bottom 8" deep; all slopes greater than 33% are lined with rock to reduce erosion (rock not shown to reveal basin contours)

Bioretention area extends into the existing ROW area where possible to maximize size

Sidewalk/pedestrian path slopes 1% toward basin to gather runoff

Note: this illustration shows an intentionally under-vegetated basin to show slope contours.

Figure 9. Conceptual drawing of a chicane with bioretention area for a neighborhood street.

In-street practices: medians

Medians are features in the center of a street that divide the street. Medians slow traffic by reducing the effective street width, and can increase safety by keeping traffic lanes separate.

Function

When designed with a flush curb and depressed bioretention area, medians can collect and infiltrate stormwater that flows along the curb and use that water to grow vegetation that shades the street and slows traffic. The bioretention area promotes vegetation, reduces stormwater volumes, and filters non-point source pollutants from stormwater.

Site selection

- Medians function best to collect stormwater on streets that are concave, or lowest at the middle of the street, and that carry stormwater along the middle of the street. The design shown is for a median on a concave street.
- Medians can be an excellent way to slow traffic entering a neighborhood from faster

- regional streets, and/or to prevent cars from making unsafe or unwanted turns mid-street.
- Medians require a minimum 5' of available (surplus) street width. See page 25 for details on preserving appropriate street width.
- Consider reducing on-street parking to make installing medians possible.
- Bioretention medians may not be appropriate for steeply sloped streets; consult local transportation departments.
- Ensure the boundaries of the in-street bioretention area are well marked and visible to traffic, bicyclists, and pedestrians.

Design and construction

- In-street bioretention areas should be sized as large as possible to increase stormwater mitigation and traffic calming effects. The median shown is a minimum of 5' wide and will vary in length depending on site conditions.
- Excavate the inside of the median to a final depth of 8" (e.g. if covering soil with 4"-8" rock, excavate 4"-8" deeper to bring the final

- depth to 8").
- Maximize the area of level bottom of the median by using steep (up to 50%) side slopes armored with rock.
- Use flush header curbs 18" deep to protect the adjacent asphalt surface.
- Create raised planting areas for trees and shrubs that do not tolerate inundation. The raised planting areas can additionally function to slow stormwater flow through the bioretention area.
- To preserve visibility, do not plant trees or shrubs that will encroach into travel lanes. A tree canopy may extend over a travel lane at a minimum height of 14' (refer to local codes).

Materials

- In areas of higher flow (concentrated flow with depths >1"-2"), line entire soil surface with 4"-8" rock to prevent scouring of soil. Areas that experience lesser flows can use coarse gravel or 1"-3" rock.
- Place 6" ceramic disks along the top of header curb to discourage entry by automobiles.
- Place bollards (posts with reflective markings) at both ends of the median to warn oncoming traffic of obstruction.
- Consider striping pavement surface in approach to median to increase visibility of feature (see plan view in Appendix).

Maintenance

- Check slopes, edges, etc. for signs of erosion and repair/reinforce as needed (before each rainy season).
- Observe bioretention feature during rain

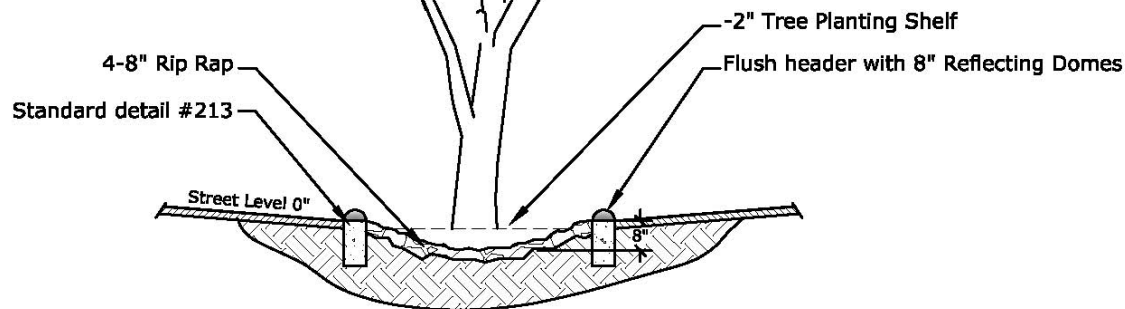

Figure 10. Typical cross-section of a median with flush curbs and depressed bioretention area. For plan view, see Appendix.

medians (continued)

events to evaluate function and make necessary adjustments.

- Prune vegetation to preserve visibility and prevent obstruction of travel lanes (annually).
- Remove accumulated sediment from bottom of basin to retain designed depth (annually).

Adapting the practice to your site

- If medians are designed for crested streets (with the highest point in the middle of the street), use a uniformly raised curb and a depressed planting area to capture and infiltrate stormwater that falls on the median itself.
- In areas with higher sediment flows, consider using sediment traps (page 22) to facilitate maintenance.

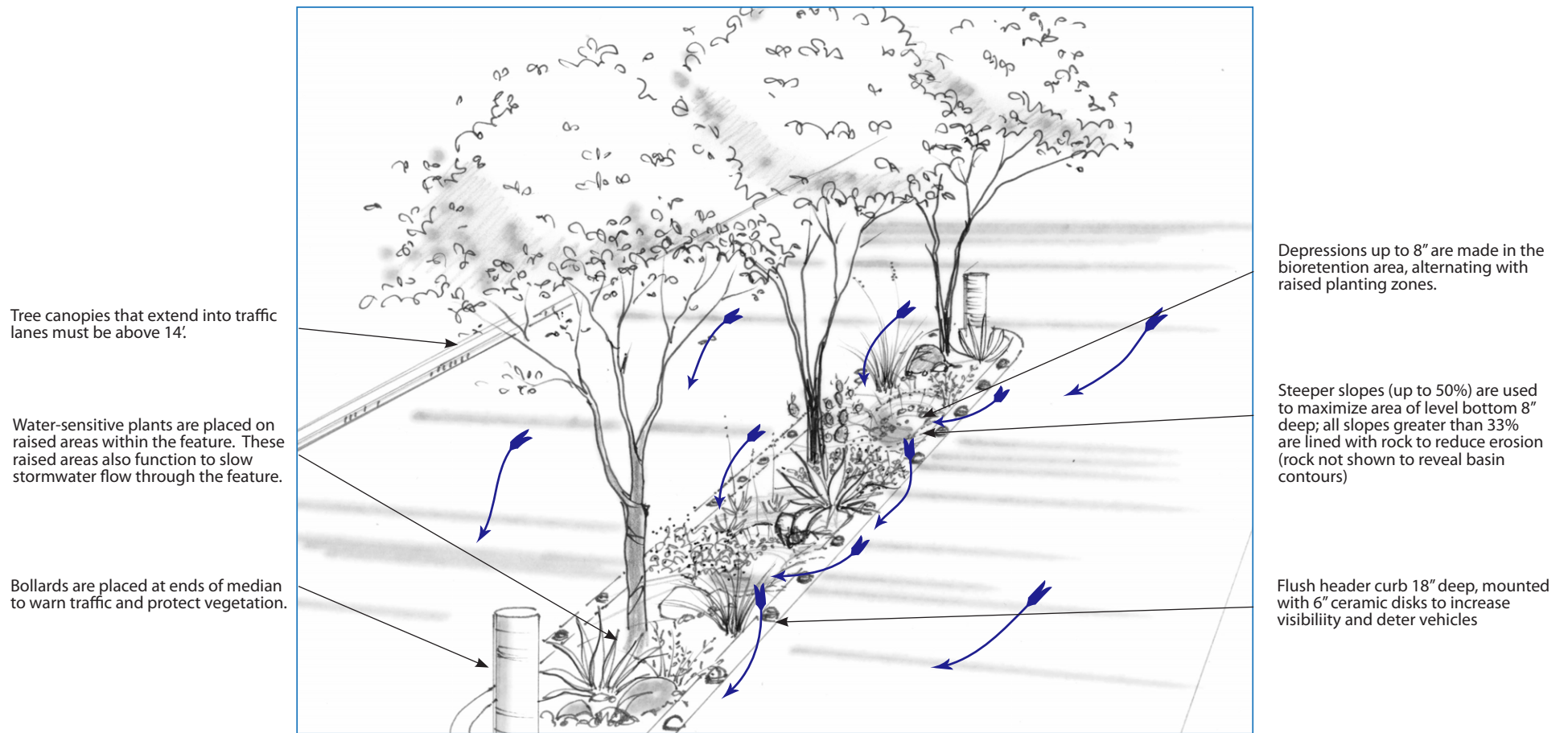

Figure 11. Conceptual drawing of a median with depressed bioretention area for a neighborhood street.

In-street practices: traffic circles

Traffic circles are used in intersections to slow traffic. They are an excellent way to reduce impervious area in a neighborhood and can be designed to capture stormwater as well.

Function

Traffic circles, when designed with a flush curb and depressed bioretention area, can collect and infiltrate stormwater that flows through intersections. The bioretention area within the traffic circle will promote vegetation, reduce stormwater volumes, and filter non-point source pollutants.

Site selection

- Traffic circles function best to collect stormwater at intersections where water flows through the intersection along a centerline. This usually occurs where the streets are concave, or lowest in the middle. The design shown is for a traffic circle in which the circle is within the main flow of stormwater.
- Traffic circles constrict the intersection and

turning width. To preserve access for emergency vehicles, codes typically require that the distance from the traffic circle header to the nearest corner of the intersection must be at least 20' (check local municipal guidelines).

- Ensure the boundaries of the in-street bioretention area are well marked and visible to traffic, bicyclists, and pedestrians.

Design and construction

- Size traffic circles to be as large as possible within allowable constraints to increase stormwater mitigation and traffic calming effects. To reduce construction costs a diameter of 20' or greater allows a cleaner cut of the asphalt along the circle edge. This reduces the time and material required to patch between the cut asphalt edge and the new concrete header.
- Excavate the inside of the traffic circle to a final depth of 8" (e.g. if covering soil with 4"-8" rock, excavate 4"-8" deeper to bring the final depth to 8").



At the top of its sub-watershed, this traffic circle (right) was designed to capture and retain the rain that falls on it.

- Maximize the area of level bottom of the traffic circle by using steep (up to 50%) side slopes armored with rock.
- Use flush header curbs 18" deep to protect the adjacent asphalt surface.
- Create raised planting areas for trees and shrubs that do not tolerate inundation.
- To preserve visibility, do not plant trees or shrubs that will encroach into travel lanes or block sight lines around the circle. A tree canopy may extend over a travel lane at a minimum height of 14' (refer to local codes).

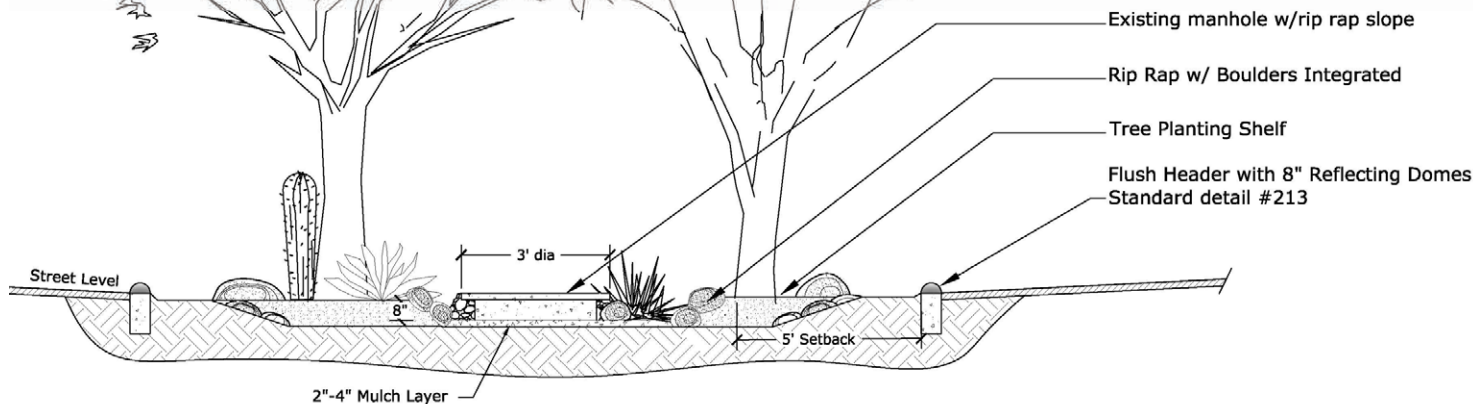

Figure 12. Typical cross-section of a traffic circle with flush curbs and depressed bioretention area. For plan view, see Appendix.

Materials

- In areas of higher flow (concentrated flow with depths >1"-2"), line entire soil surface with 4"-8" rock to prevent scouring of soil. Areas that experience lesser flows can use coarse gravel or 1"-3" rock.

traffic circles (continued)

- Place 6" ceramic disks along the top of header curb to discourage entry by automobiles.
- Place larger boulders within the traffic circle to increase visibility and prevent cars from driving over the circle (refer to local guidelines for possible height restrictions).

Maintenance

- Check slopes, edges, etc. for signs of erosion and repair/reinforce as needed (before each rainy season).
- Observe bioretention feature during rain events to evaluate function and make necessary adjustments.
- Prune vegetation to preserve visibility and prevent obstruction of travel lanes (annually).
- Remove accumulated sediment from bottom of basin to retain designed depth (annually).

Adapting the practice to your site

- If traffic circles are used in crested intersections (where the highest point is the middle of the street), use a uniformly raised curb and a depressed planting area to capture and infiltrate stormwater that falls on the traffic circle itself (see photo on page 30).

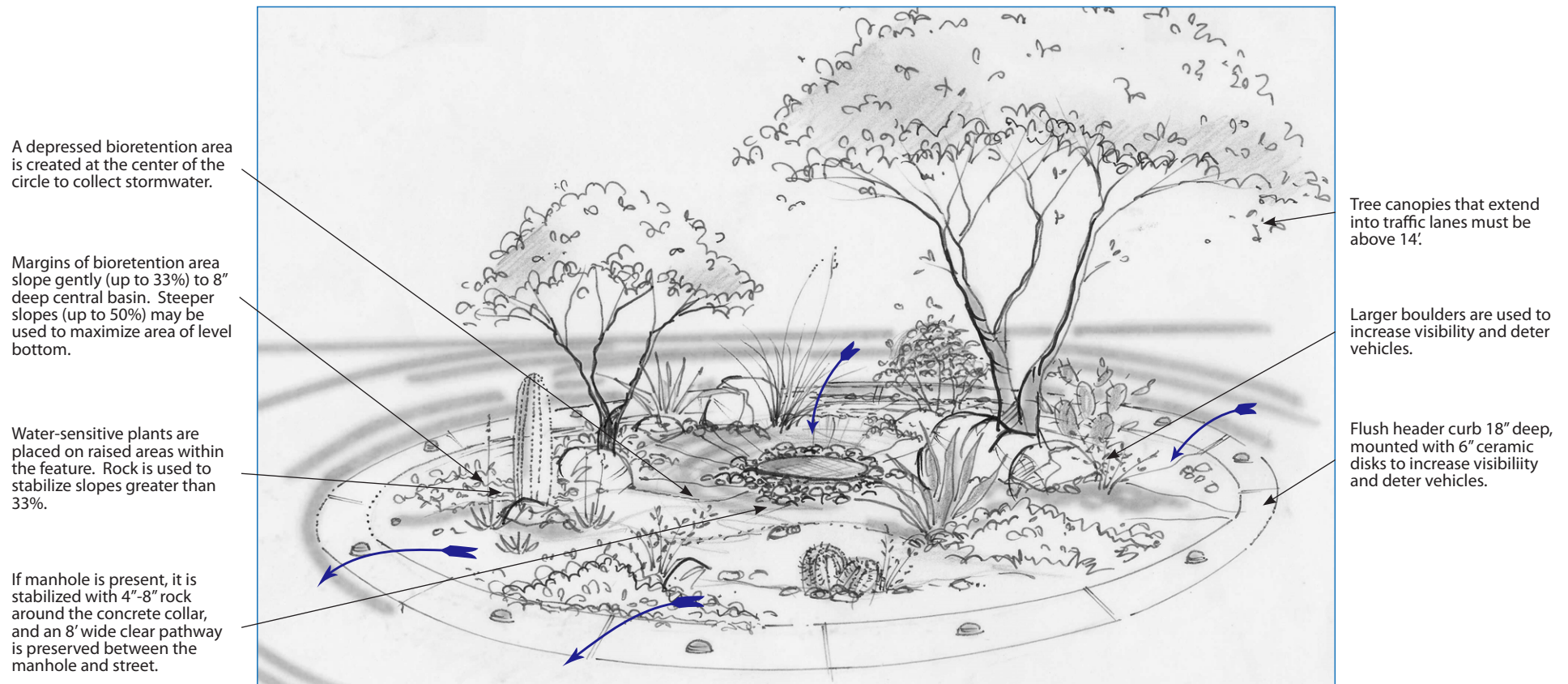

Figure 13. Conceptual drawing of a traffic circle with depressed bioretention area for a neighborhood street.

In-street practices: street width reduction

In some neighborhoods, it may be appropriate to reduce the width of streets altogether. A reduction in width of a street can occur in sections or along the entire length of the street. Reductions can be made by removing pavement and increasing the bioretention area alongside one or both street edges.

Function

A reduction in street width significantly reduces impervious area, increases safety by calming traffic speeds, collects and infiltrates stormwater, and increases vegetation and tree canopy cover. It may also provide a new area for pedestrian paths and sitting areas.

Site selection

- Street width reductions function best to collect stormwater on streets that are crested, or lowest at the street edge, and that carry stormwater along the curb. The design shown is for a reduction of a crested street.
- A street width reduction generally requires a minimum of 8' of available (surplus) street width. See page 25 for details on preserving appropriate street width.
- Take on-street parking needs into consideration. Street width reductions will usually displace existing on-street parking.
- On steeper sloped roads (> 2%) berms may need to be used to slow stormwater flowing through the bioretention features.
- Ensure the boundaries of the in-street bioretention area are well marked and visible to

traffic, bicyclists, and pedestrians.

Design and construction

- In-street bioretention areas should be sized as large as possible to increase stormwater mitigation and traffic calming effects. Generally, the encroachment width into the street is 8' and the length extends from driveway to driveway or the entire length of the street in the absence of driveways.
- Excavate the bioretention area to a final depth 8" below the street surface (if covering soil with 4"-8" rock, excavate 4"-8" deeper to have a final depth of 8").
- Where possible, extend vegetated and depressed bioretention areas into the adjacent ROW. This may be achieved by laying ROW slopes back (see Figure 15 next page), or by pouring a new curb deeper into the ROW (see plan view in Appendix).
- Use flush header curbs 18" deep to protect the adjacent asphalt surface.

- Maximize the area of level bottom of the infiltration area by using steep (up to 50%) side slopes armored with rock.
- Locate trees and shrubs that do not tolerate inundation on raised surfaces or planting shelves.

Materials

- In areas of higher flow (concentrated flow with depths > 1-2") spread 4"-8" rock over the soil surface to prevent erosion. Areas which experience lower flows can use a coarse gravel or 1"-3" rock.
- Place larger boulders within the feature to increase visibility and prevent vehicle entry.
- Place 6" ceramic disks along the top of header curb to discourage entry by automobiles.
- Place flashing solar lights on the asphalt to warn oncoming traffic of obstruction.

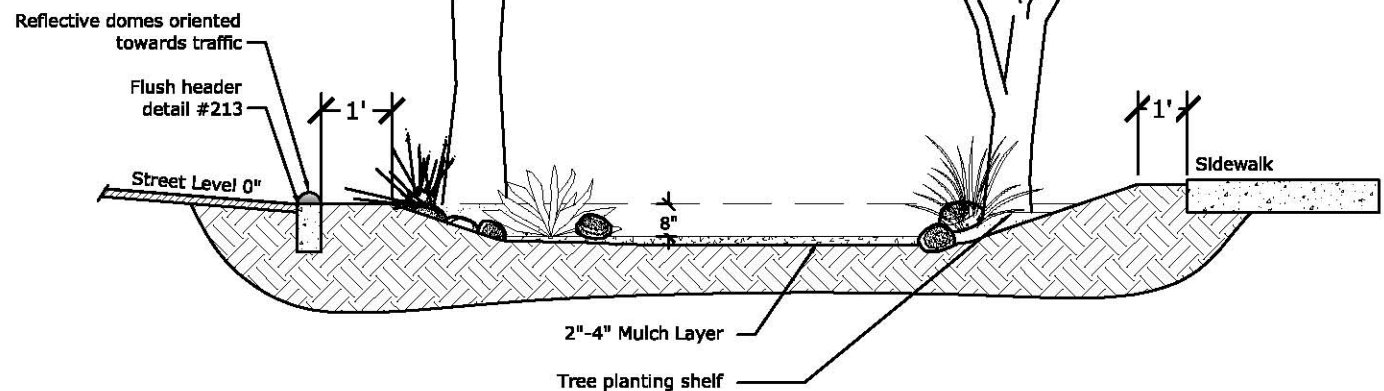

Figure 14. Typical cross-section of a street width reduction with flush curbs and depressed bioretention area. For plan view, see Appendix.

street width reduction (continued)

Maintenance

- Check slopes, edges, etc. for signs of erosion and repair/reinforce as needed (before each rainy season).
- Observe bioretention feature during rain events to evaluate function and make necessary adjustments.
- Prune vegetation to preserve visibility and

prevent obstruction of travel lanes (annually).

- Remove accumulated sediment from bottom of basin to retain designed depth (annually).

Adapting the practice to your site

- In lengthy street width reductions, parking spaces can be incorporated by cutting them in (by retaining existing asphalt) to the biore-

tention area at intervals along the street.

- In areas with higher sediment flows, consider using sediment traps (p. 22) to facilitate maintenance.
- Incorporate creative methods such as seating areas, pathways or public art to enhance the community value and utility of larger street width reductions.

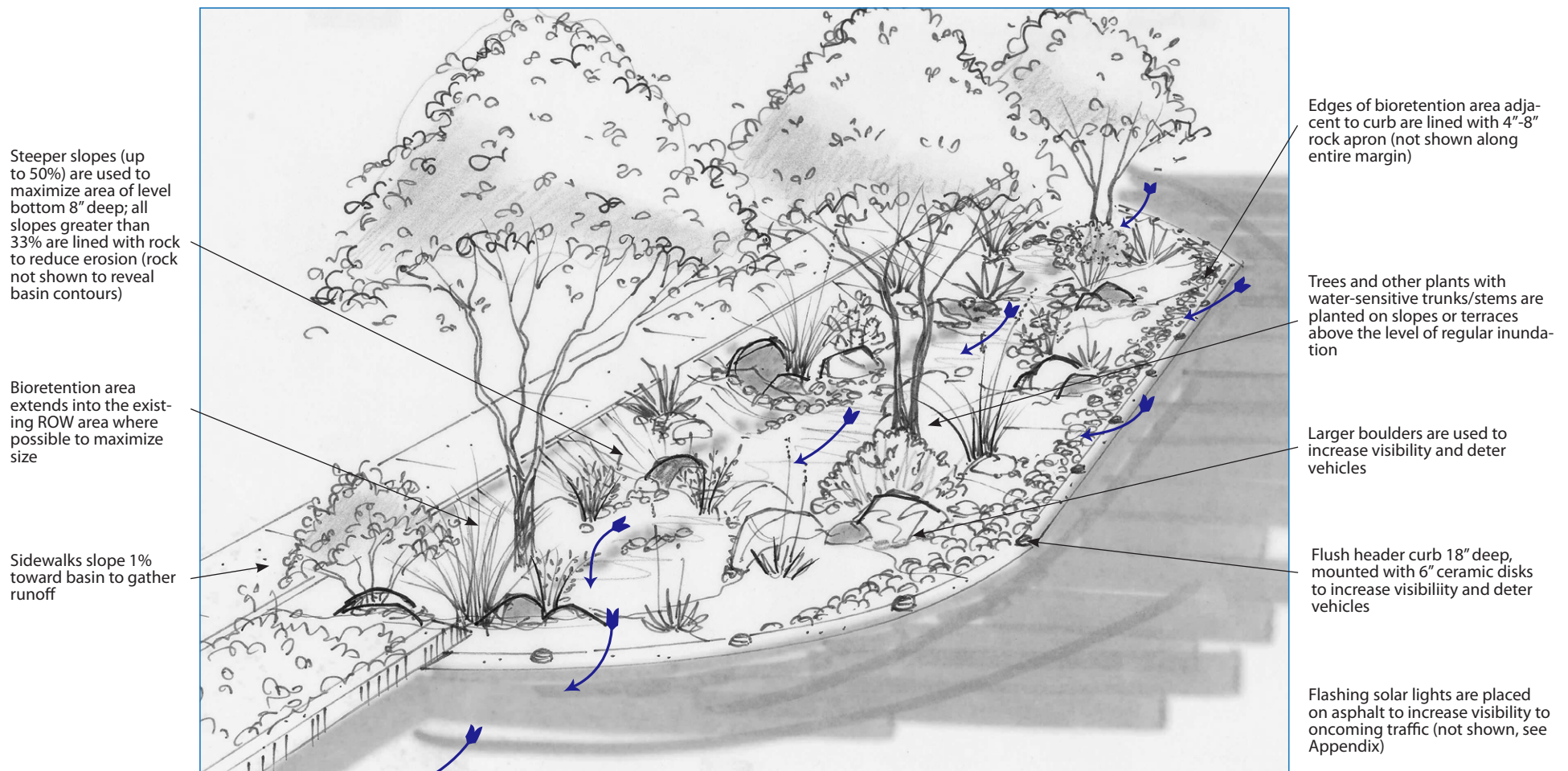

Figure 15. Conceptual drawing of a street width reduction with depressed bioretention area for a neighborhood street.

Parking lot practices

The cost of parking lots

Whether at a church or a “big box” store, parking lots are a major element of many neighborhoods. Their presence, though often necessary, has several consequences for the local environment and neighborhood character:

Stormwater

One 8.5'x20' asphalt parking space generates about 100 gallons of runoff in a 1" storm. This runoff adds up quickly, and in many older neighborhoods, this stormwater is sent out into the street or directly into washes or streams. To deal with this issue, most municipalities now require parking lots to be outfitted with detention/retention basins that capture stormwater runoff. These detention basins are a kind of grey infrastructure that often has serious drawbacks. Detention basins commonly:

- take up otherwise buildable land (lot yield)
- create vacant, often unusable areas without landscaping that can become an eyesore
- do not address water quality issues
- can require fencing or walls
- require constant maintenance
- serve only one function—slowing runoff

Urban heat island

Parking lots create great expanses of asphalt or concrete that contribute significantly to artificial warming of towns and cities. Municipalities commonly have minimum landscape

requirements for parking lots that begin to mitigate this issue by shading hardscape. The City of Tucson, for instance, recently passed stringent regulations that require one tree to be planted for every four parking spaces in new parking lots, and that at least 50% of the lot be shaded by mature tree canopy.

Neighborhood character and livability

Neighborhoods are often in favor of large parking lots as they help keep parking from businesses off of residential streets. However, large expanses of asphalt can create hot, barren areas that detract from neighborhood aesthetics as well as from a sense of being a part of a “neighborhood” at all.

Green infrastructure for parking lots

GI parking lot practices take the function of the detention basin and spread it throughout the site, creating multiple bioretention areas that collect stormwater close to its source. As they do on neighborhood streets, these practices integrate stormwater management with landscape improvements that can:

- increase the amount of buildable land (lot yield) or land available for green spaces
- create more attractive parking landscapes that appeal to both users/customers and neighborhood residents
- cool local temperatures
- clean and infiltrate stormwater

- reduce landscape irrigation needs
- reduce maintenance needs

Retrofitting vs. new construction

Cities like Tucson are doing much through codes and ordinances to improve new parking lots through progressive stormwater, landscape, and/or green infrastructure requirements like those mentioned above. Several excellent references already provide information on incorporating GI practices into new parking lot construction^{12,15}.

However, most of the hundreds of square miles of existing Southwestern parking lots do not incorporate these best practices. At these sites, GI practices can become part of resurfacing, reconstruction, and revitalization projects.

This section provides examples of ways to retrofit existing parking lots with GI approaches to improve neighborhood environments.

parking lot practices (continued)

Replace asphalt with bioretention

Existing parking lots often have inefficient layouts with wasted space. Even in those that do not, a few parking spaces can often be sacrificed to create bioretention areas. Replacing asphalt with bioretention has the double effect of reducing impervious area while creating spaces to collect and infiltrate runoff. Follow these best practices:

- to protect the asphalt surface, reinforce cut asphalt edges with flush concrete header, 6" wide x 12"-18" deep
- in areas where there is a risk of motorists driving into bioretention areas, use concrete curb stops at the pavement margin or landscape boulders within the basin to prevent vehicle entry
- alternately, a raised curb with curb cuts can be used to allow stormwater flow while preventing deterring vehicles
- plan for where overflow will exit from any bioretention features



At this Tucson City Council Ward office, asphalt was removed from an unused portion of the parking lot. Runoff from the lot (foreground) and the adjacent building fills the unfinished basins in a summer storm.



One year later, stormwater-fed native vegetation grows to soften the offices' stark facade and shade an outdoor patio. Note that basin slopes are lined with rock to reduce erosion.



At this University of Arizona parking lot, an unused space happened to coincide with the lot's natural low point. The asphalt was removed and a bioretention basin installed. Note concrete header and curb stops. The basin's interior was terraced and shaped to distribute stormwater evenly. Overflow exits the back left corner to the street.



Parking lots (continued)

Create bioretention in ROW/ landscape buffer areas

Where space allows, bioretention basins or swales can be incorporated into existing impervious areas within or adjacent to existing parking lots. Methods will vary widely depending on the type and amount of space available.

- use curb cuts, flush curbs and/or natural spillover points to collect stormwater in bioretention features.
- speed bumps can be used as a retrofit tool



Before: At this University of Arizona parking lot, small curb cuts allowed stormwater to flow past existing trees onto the pedestrian area in the ROW, and then on to the street.

to direct stormwater in existing parking lots.

- first-hand observation is essential when designing retrofit features -- it's cheaper than surveying and will help you catch small topographical details that can dramatically affect stormwater flow (for instance, at the site shown in the photo progression at right, observing the site in a storm revealed a small bump in the pavement that sends runoff from both an alley and parking lot into an earthen ROW area.



After: A long, thin swale was installed and additional trees and shrubs planted to capture and use runoff from the lot.

This progression of photos shows a ROW area that collects runoff from a UA parking lot (above wall at right).



December 2008: Runoff from the lot and adjacent alley wash over bare dirt and the sidewalk into the street.



April 2009: newly-dug basins capture storm runoff to feed young plants.

August 2010: Native grasses, shrubs and trees thrive just 18 months after installation.



Maintenance

Like any man-made feature, green infrastructure practices must be maintained to remain functional. General maintenance tasks usually include:

- watering plants
- removing weeds
- clearing stormwater inlets of debris and vegetation
- pruning trees and shrubs for safety (pathways/streets), visibility, plant health and aesthetics
- removing sediment and trash
- replacing dead plants
- adding organic mulch
- repairing erosion
- repairing human-caused damage

Without adequate planning for maintenance from the outset of a project, GI features may lose their capacity to function properly and become perceived as eyesores or hazards by the community. Maintenance responsibility, necessary funding, and plans for enforcement of maintenance requirements must be accounted for at the beginning of project planning.

Design for maintenance

To facilitate long-term maintenance, take the following into consideration when designing GI practices:

- **Remove perennial weeds during site preparation.** For instance, throughout Arizona, Bermuda grass is a persistent, deep-

rooted non-native turf grass that aggressively invades disturbed soil. If established within a landscape, it is virtually impossible to remove without disturbing other plant roots, or affecting desirable plants through overspray of herbicides. If the grass is removed through deep excavation and/or spraying during the preparation phase of a project, later maintenance needs can be significantly reduced.

- **Use native, drought-adapted plants and climate-appropriate watering schedules.** Desert plants are adapted to prolonged periods of drought interspersed with intermittent rainfall. If constant irrigation is applied, plants can grow too quickly, developing weak growth and requiring constant pruning. If a regionally-appropriate schedule of deep, infrequent watering is maintained (see page 13), many plants will require less pruning through the year. Trees will develop deeper root systems that will help them withstand high winds.
- **Prune native trees and shrubs to natural growth forms.** Desert plants have characteristic shapes and growth forms that are part of what make our regions unique. Most arid-adapted trees, for instance, naturally grow multiple trunks. When pruned into “lollipop” trees of a single stem and high canopy they require much more pruning, and are more likely to be blown over by wind. Where feasible they should be al-

lowed to grow in their natural form. Shrubs pruned into fine sculptures obviously require more maintenance. Take natural plant growth forms into account when planning landscape designs.

- **Use organic mulch wherever possible.** Since it can be easily removed and replaced, organic mulch facilitates sediment removal versus gravel or rock mulch. Leaf drop and chipped tree trimmings can be used to replenish mulch instead of being constantly picked up and hauled away (which is often required for gravel surfaces).
- **Use sediment traps (page 22).** If sediment traps are not used at GI sites armored with rock or gravel, sediment removal will be labor-intensive. This may be achieved by total removal of rock and sediment, and subsequent grading and replacement of rock.
- **Test sediments for persistent pollutants.** GI practices collect and concentrate non-point source pollutants, some of which will not be broken down by bioretention processes. Sediments containing these persistent chemical pollutants will need to be removed and in some cases be disposed of in landfills. More localized case studies and research are needed in this area to determine rates of pollutant accumulation in Southwestern GI sites and best practices for disposing of them.

References

1. Environmental Protection Agency, Office of Water (US) [EPA]. (1999, September). Storm Water Technology Fact Sheet: Bioretention. Washington, DC: EPA; 1999 Sep. 8 p. Retrieved from: <http://www.epa.gov/owm/mtb/biortn.pdf>. Accessed 2010 July 7.
2. Eugster G. Seven Principles of Green Infrastructure. In: Proceedings of the 2000 American Planning Association National Planning Conference. 2000 Apr 15-19; New York, NY. 2000. 6p. Available from: <http://www.asu.edu/caed/proceedings00/EUGSTER/eugster.htm>. Accessed 2010 July 7.
3. Green Infrastructure Principles [Internet]. Washington, DC: National Association of Regional Councils; 2006; Available from <http://www.narc.org/pubs/main//activities/environment/green-infrastructure-and-landcare/green-infrastructure-principles.html>
4. Benefits of trees in urban areas [Internet]. Broomfield, CO: Colorado Tree Coalition; 2010; Available from: <http://www.coloradotrees.org/benefits.htm>
5. Bartens J, Day S, Harris J, Dove J, Wynn T. Can urban tree roots improve infiltration through compacted subsoils for stormwater management? *J Environ Qual* 2008. 37: 2048-2057.
6. Corman G. Choosing mesquite trees for landscapes. In: *Gardening Insights* [Internet newsletter]. 2009 July. Available from http://www.gardeninginsights.com/pdfs/Monthly%20letter%2007_09.pdf
7. Lancaster B. Rainwater harvesting for drylands and beyond Vol. 1. Tucson, AZ: Rain-source Press; 2006. 183 p. (Water harvesting calculations can be found at: <http://www.harvestingrainwater.com/rainwater-harvesting-infosources/water-harvesting-calculations/>)
8. Stewart, Dave. (Pima Cty Regional Flood Control District). Conversation with: James MacAdam. 2009 Nov.
9. Environmental Protection Agency, Office of Water (US) [EPA]. (2009, December). Technical Guidance on Implementing the Stormwater Runoff Requirements for Federal Projects under Section 438 of the Energy Independence and Security Act. Washington, DC: EPA; 2009 Dec. 61 p. Retrieved from: http://www.epa.gov/owow/NPS/lid/section438/pdf/final_sec438_eisa.pdf. Accessed 2010 August 4.
10. Lancaster, op. cit. pp. 136-141. Also available at: <http://www.harvestingrainwater.com/wp-content/uploads/Appendix4PlantLists.pdf>
11. Wittwer, Gary. (City of Tucson Department of Transportation, Landscape Architect). Conversation with: James MacAdam. 2010 February.
12. Lancaster B. Rainwater harvesting for drylands and beyond Vol. 2. Tucson, AZ: Rain-source Press; 2006. 419 p. (p. 18).
13. Cromell C, Miller J, Bradley LK. 2003. Earth-Friendly Desert Gardening. Phoenix, AZ: Arizona Master Gardener Press; 2003. 136p. (p. 71).
14. Bikesafe Bicycle Countermeasure Selection System [Internet]. Washington, DC: Department of Transportation, Federal Highway Administration (US). Available from: <http://www.bicyclinginfo.org/bikesafe/background.cfm>
15. Phillips AE, editor. City of Tucson Water Harvesting Guidance Manual. Tucson, AZ: City of Tucson; 2005. 35p.

Glossary

Note: these definitions were developed for the purposes of this manual, and are not necessarily intended to be generalized for other uses.

apron: a reinforced area at the inlet to a bioretention feature to prevent erosion from stormwater; usually made of set-in rock

basin: an earthen depression designed to collect and infiltrate stormwater

bioretention: the use of vegetation and soils to clean stormwater runoff

green infrastructure: constructed features that use natural processes to provide environmental services such as capturing, cleaning and infiltrating stormwater; creating wildlife habitat; shading and cooling streets and buildings; and calming traffic

hardscape/impervious area: surface that does not allow water to infiltrate into the ground (e.g. asphalt, concrete)

infiltration/percolation: movement of water into the soil

native plants: a plant that is indigenous or naturalized to a region over a given period of time

non-point source pollution: pollution that

comes from dispersed sources--like auto oil, pet waste, herbicides, and sediment--and that is often carried by/in stormwater

right-of-way (ROW): the area along a street between the curb and property lines

runoff/stormwater: rainfall that has hit the ground and begun to run off

swale: an elongated, shallow depression designed to infiltrate and/or transport stormwater

urban heat island effect: the phenomenon of urban areas being warmer than surrounding rural/undeveloped areas; due to developed areas' higher proportion of heat-trapping surfaces

traffic calming: the practice of slowing traffic through residential areas through the use of roadway constrictions, vegetation or other features

Appendix: curb cut & basin, rock-lined, plan view

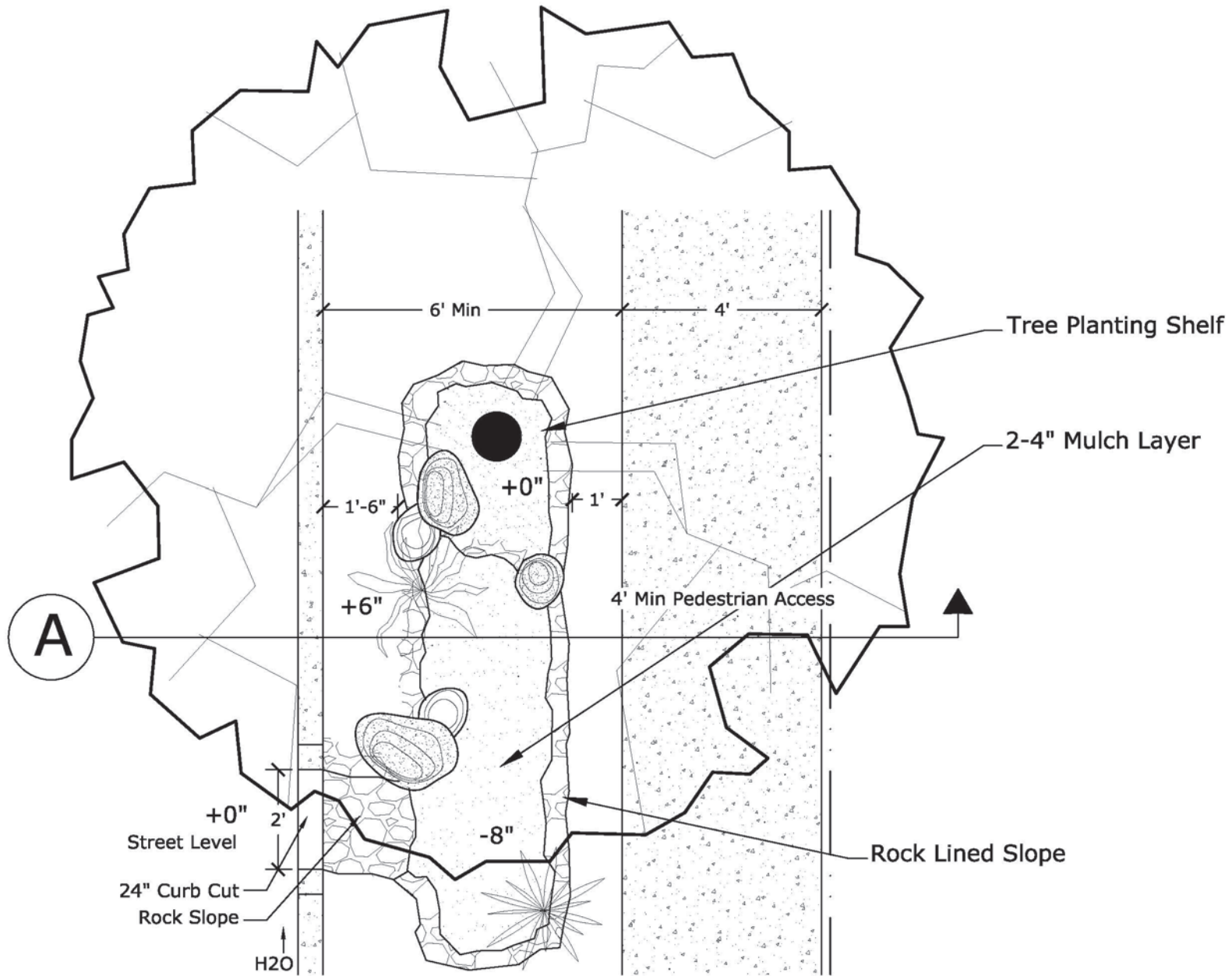

Appendix: curb cut & basin, shallow slope, plan view

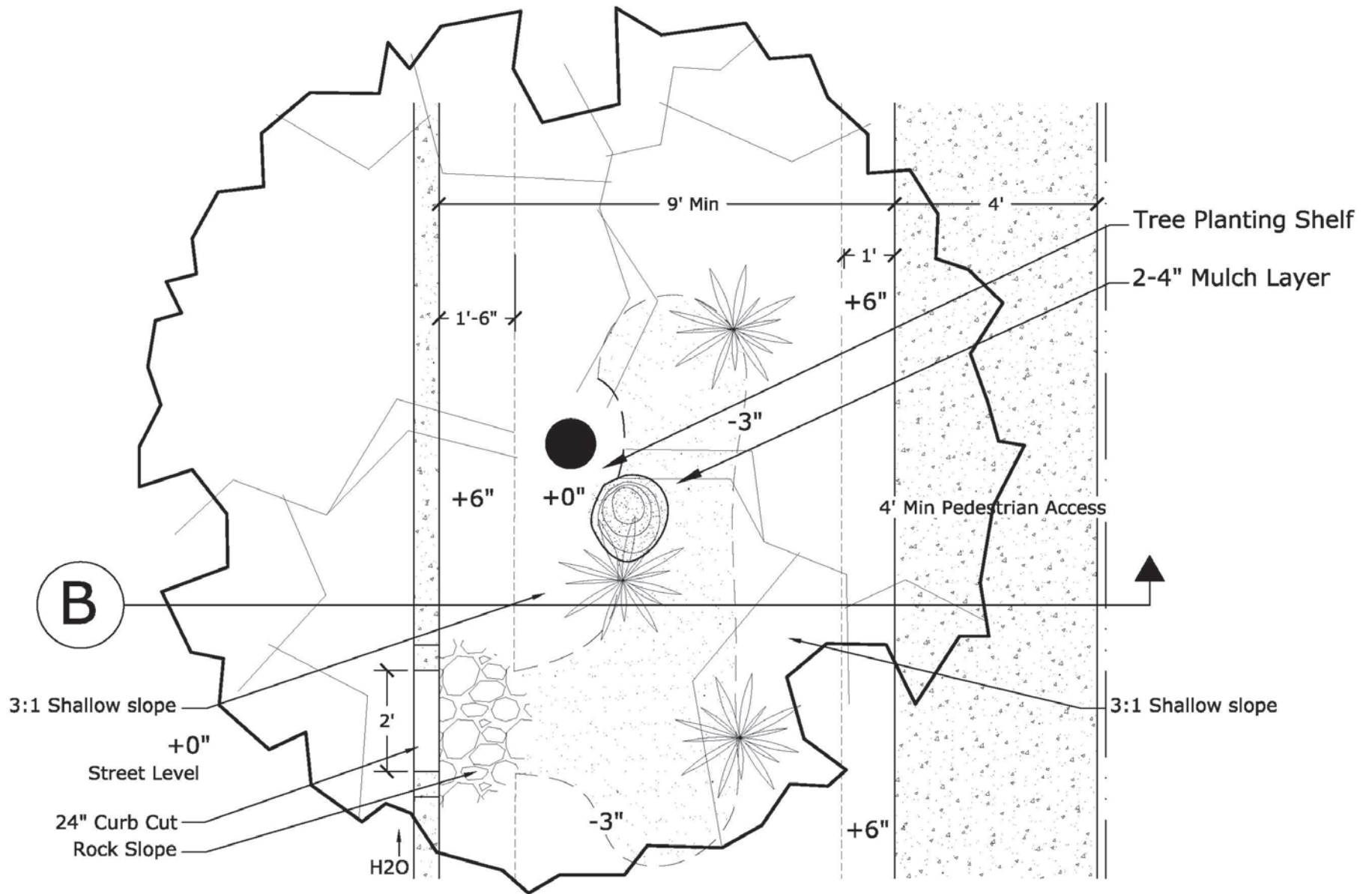

Appendix: chicane, plan view

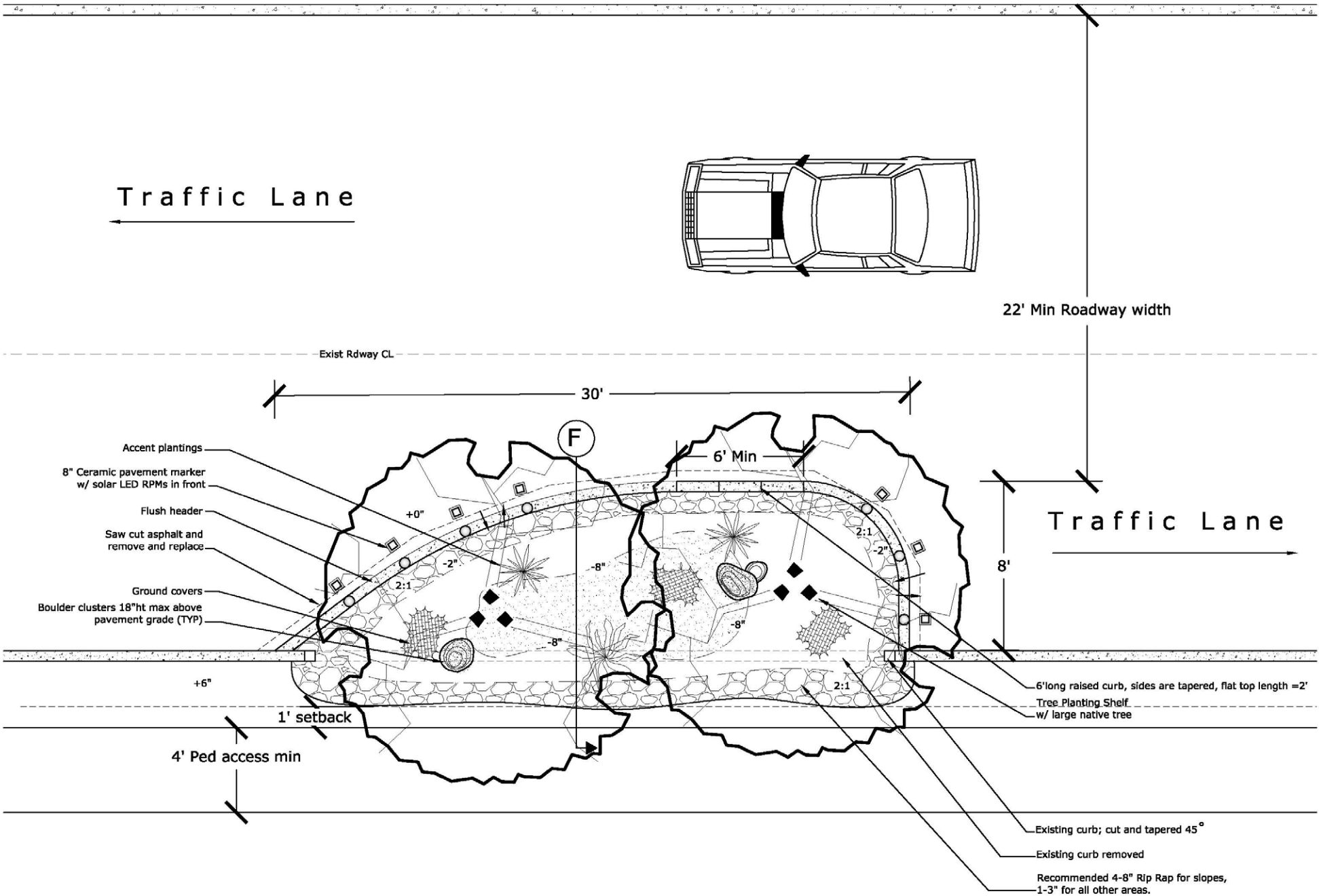

Appendix: median, plan view

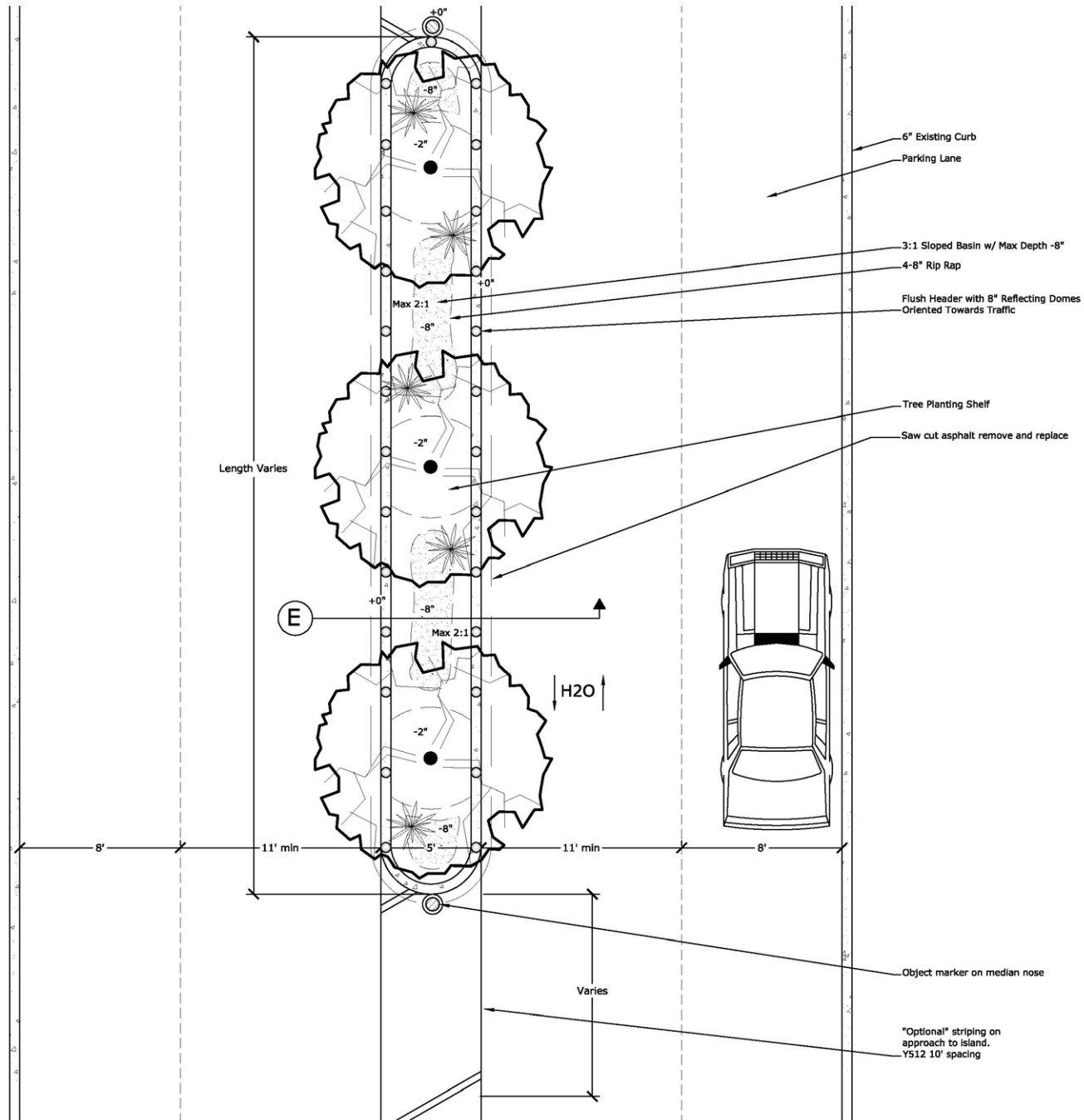

Appendix: traffic circle, plan view

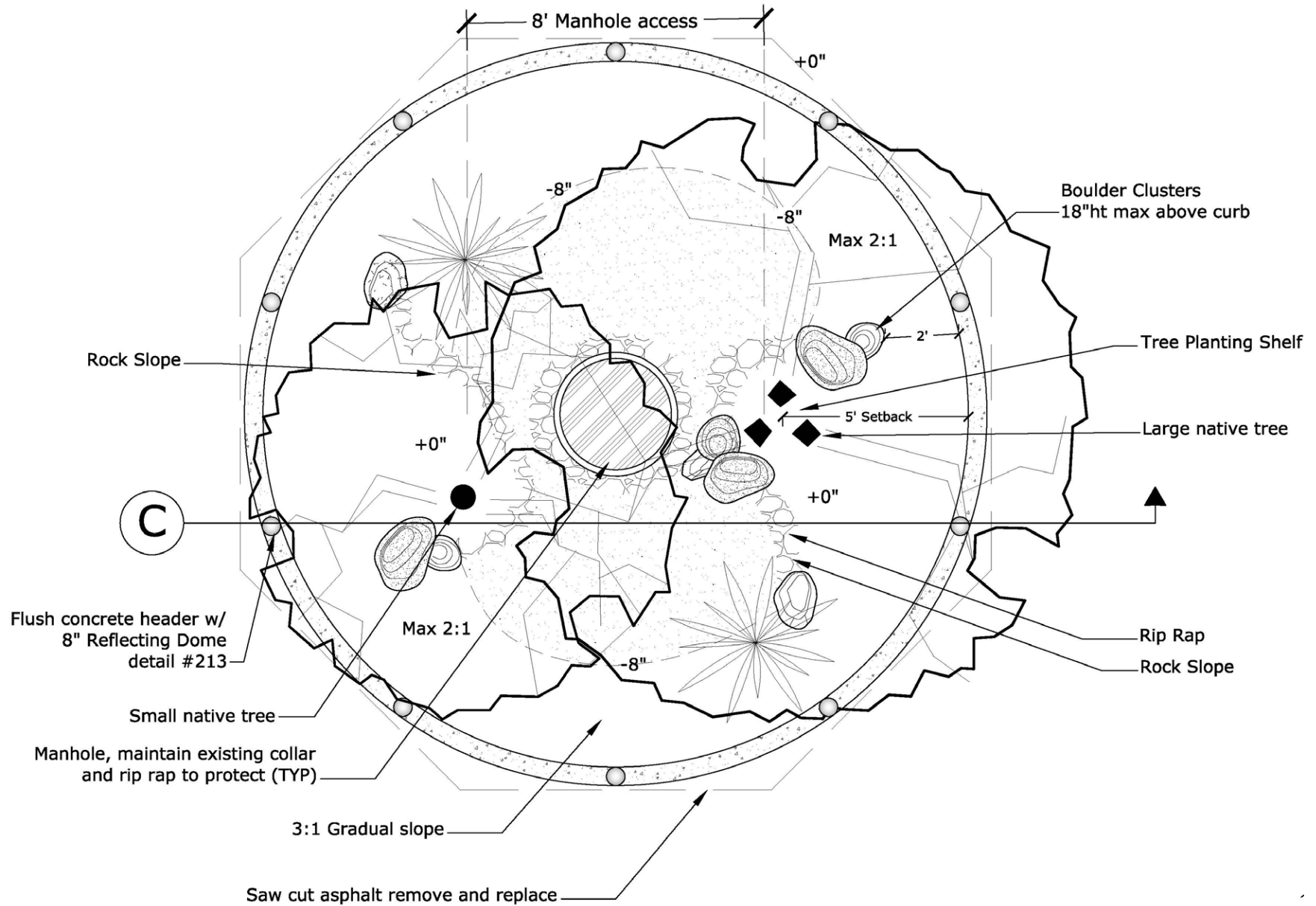

Appendix: street width reduction, plan view

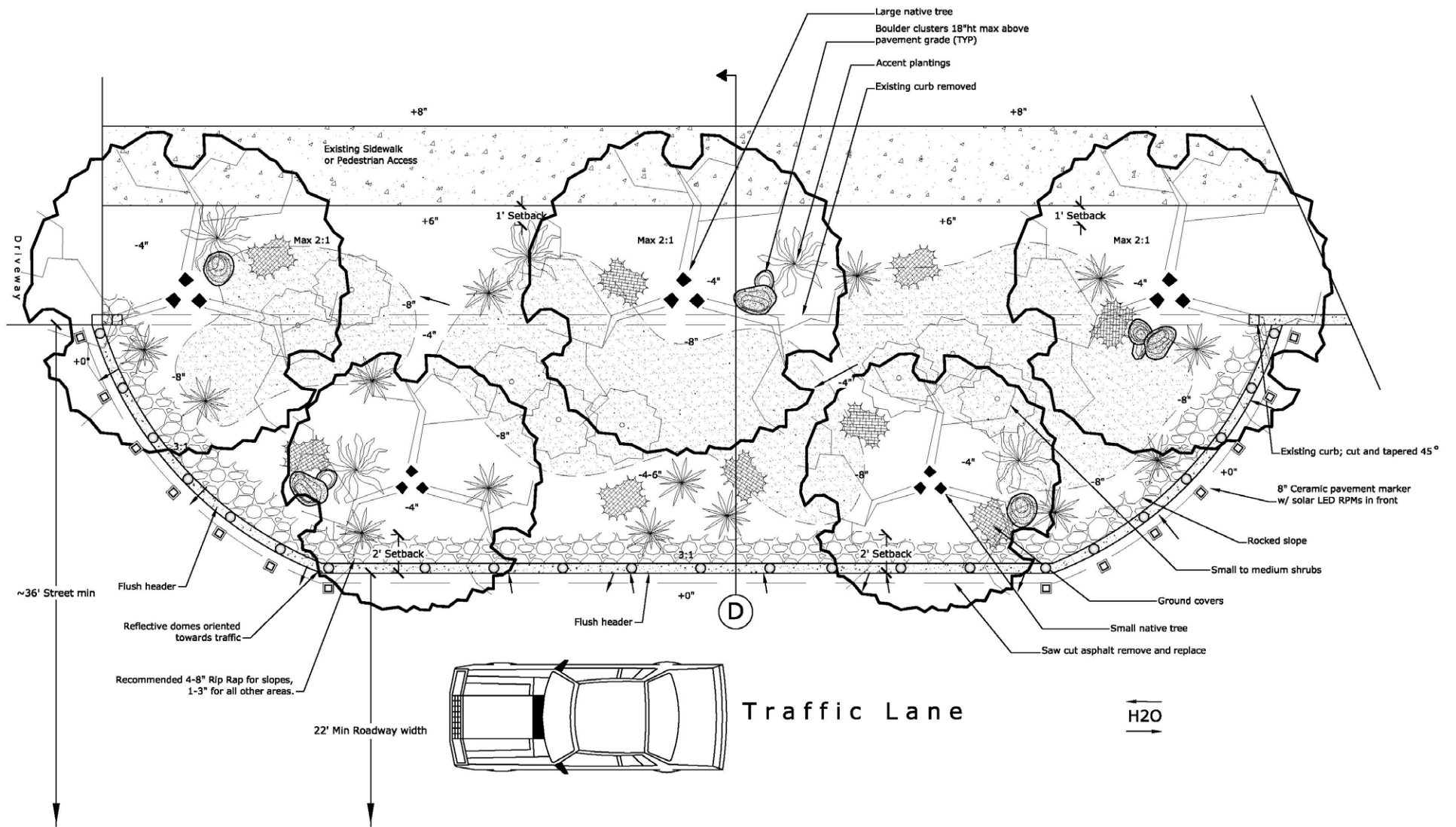

Acknowledgments

Watershed Management Group would like to thank the Arizona Department of Environmental Quality and the United States Environmental Protection Agency for funding the development of this manual through a Water Quality Improvement Education grant. We would also like to thank the Arizona State Forestry Division, which provided funds for the development of the green infrastructure standards and designs through a Community Forestry Community Challenge Grant.

This manual is based on the experience, hard work and contributions of many others. In particular we would like to thank:

Brad Lancaster, www.harvestingrainwater.com

Christine Wilke, Rincon Heights Neighborhood Association

Dave Stewart, Civil Engineering Assistant, Pima County Regional Flood Control District

Gary Wittwer, Landscape Architect, City of Tucson

Most of all, we wish to acknowledge the dedication, hard work and selflessness of the hundreds of Watershed Management Group volunteers who have contributed to the dozens of green infrastructure installation workshops that form the basis for this manual.

Illustration credits:

Technical drawings of green infrastructure practices (pages 18, 20, 22, 26, 28, 30, 32, 40-45) are by Allen Denomy, www.denomydesigns.com.

Conceptual drawings of green infrastructure practices (pages 10, 19, 21, 27, 29, 31, 33) are by Dean Alexander, www.blueagavedesign.com.



About Watershed Management Group

Watershed Management Group (WMG) is a 501(c)(3) non-profit organization whose mission is to develop community-based solutions to ensure the long-term prosperity of people and health of the environment. We provide people with the knowledge, skills, and resources for sustainable livelihoods. WMG's programs include:

Green Streets - Green Neighborhoods

WMG works with neighborhoods, communities, governments and other groups to promote and install green infrastructure practices that improve community livability. Our program provides citizens with skills and resources to take action on issues of flooding, stormwater pollution, urban heat island effect, alternative transportation, and beautification in their own communities.

Water Harvesting Certification

The only program of its kind in the nation, WMG's Water Harvesting Certification combines hands-on and classroom instruction to provide participants with a thorough, on-the-ground understanding of the core practices of water harvesting. The 65-hour curriculum includes training in integrated systems design, water harvesting earthworks, cisterns/tanks, greywater systems, and sustainable/edible landscaping.

Water Harvesting Demonstration Sites

Through public, educational volunteer workshops, WMG has installed water harvesting demonstration sites at various schools, nonprofits, government offices and business in southern Arizona. All sites demonstrate methods to capture rainwater and greywater to irrigate landscapes with native and edible plants.

WMG Co-op

WMG's popular Co-op uses a barn-raising model where people volunteer their labor to build sustainable systems (like water harvesting systems) and in turn earn the ability to host a workshop at their own home with a volunteer crew. The program makes green improvements affordable while building community.

Schoolyard Water Education

WMG partners with K-12 schools to create and implement curriculum focused on water conservation, wildlife habitat, and local food production. Through WMG's workshop-based experiential model, students and adult volunteers install passive water harvesting earthworks, cisterns, edible gardens, and native gardens on school campuses.

Conserve to Enhance (C2E)

The C2E Program links water conservation efforts with watershed restoration to ensure that water conservation will translate into benefits for the environment. Businesses and individuals participate by tracking the amount of money saved through water conservation practices, and then donate the value of their savings to projects that directly benefit local riparian areas.

WMG International

WMG has worked with communities in Latin America, Africa, and India to improve rural watershed conditions, develop access to clean water, and improve sanitation.

For more information visit: www.watershedmg.org



P.O. Box 65953
Tucson, AZ 85728

520-396-3266
www.watershedmg.org